

**SENSORS
THE WORKS**

November 2010

AUS\$ 13.90 - NZ\$ 16.90 - SAR 99.95 £ 4.65

+ The 5532 OpAmplifier - part 2

Elektor



+ Sensorless Motor Speed Measurement

+ Designing & Making Basic Antennas

+ Wireless Instrumentation Network

+ Real Time Gas Measurements

+ Portable Oxygen Meter

+ Camera Interval Timer

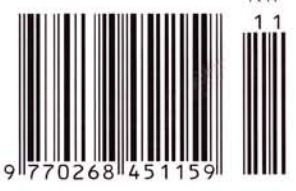
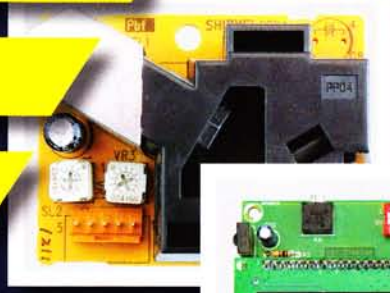

NXP mbed DESIGN CHALLENGE



Start prototyping the *mbed way!*

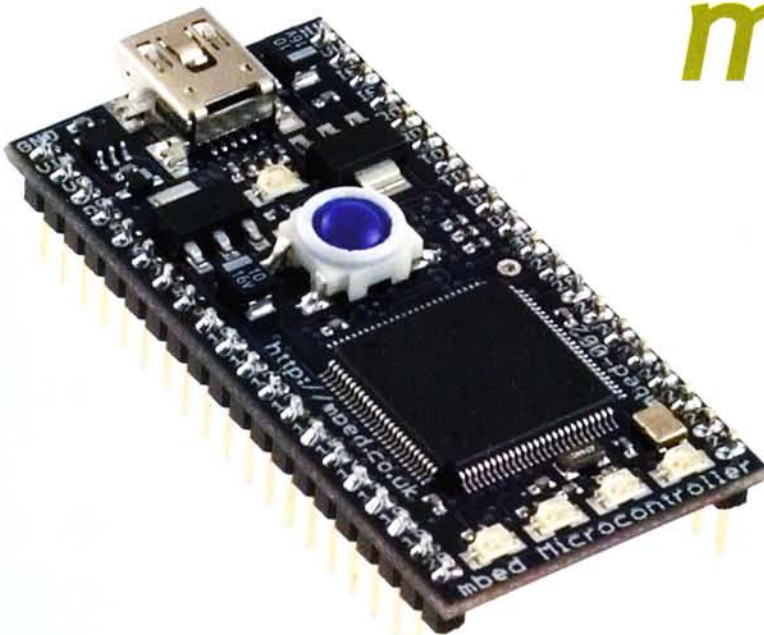

Redefine the way people build prototypes! NXP and ARM/mbed are challenging you to use the mbed NXP LPC1768 prototyping board and mbed online "Cloud" compiler to develop an innovative hardware- or software-based application. Succeed, and you could walk away with part of a prize pool worth \$10,000!

**Deadline for entries is
February 28, 2011**

Register for the challenge at
www.circuitcellar.com/nxpmbeddesignchallenge

NXP mbed Design Challenge empowered by:



SAVE YOUR POWER WITH

mikroC, mikroBASIC and mikroPASCAL PRO for dsPIC30/33 and PIC24 COMPILERS SUPPORTED

POWERED BY PIC24F16KA102 WITH XLP TECHNOLOGY

WIRELESS SUPPORTED

Touch Sense ON BOARD



Easy24-33 v6

The Easy24-33 v6 development system supports 14-, 18-, 20- and 28-pin PIC24 and dsPIC33 devices from Microchip. It comes with a PIC24F16KA102 (PIC24 16-bit Microcontroller featuring nanoWatt XLP™ for eXtreme Low Power consumption) designed for power constrained and battery powered applications. The system features a USB 2.0 programmer with mikroICD and many peripheral modules, such as Touch Sense, Serial RAM, EEPROM, etc, suitable for developing low power, sensor and wireless devices.

CHECK OUT our accessory boards compatible with Easy24-33 v6!



THE EASIEST WAY TO CREATE YOUR OWN LOW POWER DEVICES

MikroElektronika
DEVELOPMENT TOOLS | COMPILERS | BOOKS

...making it simple

GET IT NOW
www.mikroe.com

Privileged

When it comes to (high end) audio, Elektor has standards and a reputation to maintain. Many of our amplifier designs have reached 'legendary' status and apparently are still built. In recent years, audio as a subject has suffered under the weight of microcontroller projects, and we promise to make amends.

Unusually, our current audio amplifier project (of which the first instalment appeared last month), is not a pure in-house design but originally developed by Douglas Self, a widely respected author of articles and books on the design of audio amplifiers. However in good Elektor fashion the 5532 OpAmplifier design was tweaked and optimized. Ton Giesberts here at Elektor Labs was asked to supervise the post engineering phase of the project. And what do you think happens if let two ambitious audio designers work together on a project? They will not take each other's word for any decibel when approaching the noise floor of the AP analyser! Questions, comments, criticisms and amendments got sent back and forth over the past few months. Eventually this led to a design that's improved and polished in some areas; 'the best of two minds', so to speak, right up to the board design and the publication proper.

The resulting project is a rather unusual power amplifier with an output stage that consists of cheap, paralleled opamps — lots of them! If you are interested, do not hesitate to build your own OpAmplifier. In terms of parts cost, it won't break the bank, apart from the power supply of course which is traditionally the biggest cost factor. Let us know what you think of it! My colleague Harry Baggen was the first to be able to listen to the OpAmplifier within the peace of his own home and he was pleasantly surprised by the performance of all those little opamps. It sure is a privilege to be an Elektor editor — with the soldering irons still smoking you can listen to the latest audio creations straight away.

Jan Buiting, Editor

- 6 **Colophon**
Who's who at Elektor magazine.
- 8 **News & New Products**
A monthly roundup of all the latest in electronics land.
- 14 **Introducing mbed**
- 16 **What's That in the Air?**
Here we tackle the theory and methods of real-time oxygen and hydrocarbon compound measurements.
- 20 **MicroFuel Cell Measures Oxygen Concentration**
A must read and must have not just for divers and cave explorers.
- 24 **The 5532 OpAmplifier (2)**
Besides construction and test results, the closing instalment also covers bridged operation and modification for 4 ohms.
- 32 **Sensorless Motor Speed Measurement**
A technology is described that enables the speed of an electric motor to be measured by means of an ammeter circuit.
- 36 **Wireless Instrumentation Network**
Add Maxstream and Xbee modules, stir in some Arduino and you have a measurement network with no wires.
- 41 **Portable Energy**
Alternative energy sources for your cell phone, iPod and other gizmos normally operating from rechargeable batteries.
- 43 **JTAG Live Buzz (E-Labs Inside)**
JTAG is increasingly used for boundary scan methods, calling for new IC architectures.
- 44 **USB port from a 9-pin sub-D connector (E-Labs Inside)**
FTDI have again come up with the goods!
- 46 **Rapid Prototyping (E-Labs Inside)**
The AutoFab product from Muvium

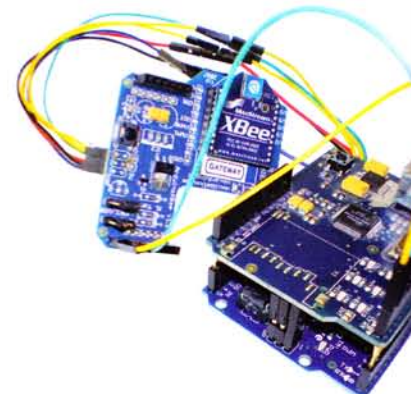
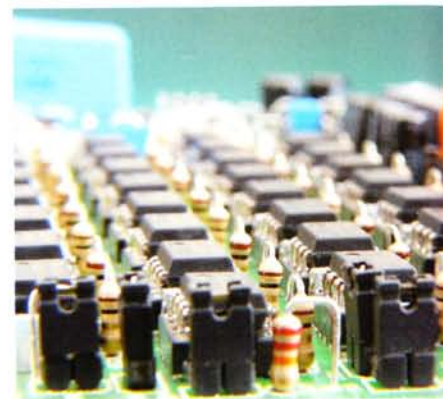

CONTENTS

Volume 36
November 2010
no. 407

20 MicroFuel Cell Measures Oxygen Concentration

We have previously described carbon dioxide sensors based on chemical and optical principles in Elektor, and an oxygen sensor complements these designs nicely. The meter described here is based around an Elektor Minimod18 microcontroller board featuring an ATmega328 microcontroller and a two-line backlit LCD panel.

24 The 5532 OpAmplifier (2)

This month we get real by building the 5532 OpAmplifier project and putting it through its paces. The test results are pleasing if not impressive and definitely put the design in the high-end audio class. Bridging and 4 ohm conversion are also described.

36 Wireless Instrumentation Network

In this project, the node consists of an Arduino nodule with an XBee shield module. The gateway also consists of these two modules, plus an EtherShield module for communication with the Internet. The resulting measurement data can be retrieved from the Pachube website.

70 Camera Interval Timer

The camera shutter operating system described here enables you to take photos at a predefined interval, or to trigger two cameras together for stereoscopic shots. This way you can take a series of photos every 30 minutes of a flower as it opens, a baby bird hatching, etc. so as to include them in a video. The system was originally designed for a Canon EOS camera, but it can readily be adapted for other cameras that are able to be remote controlled.

presents a new approach to circuit prototyping.

- 48 Image Processing Made Easy**
Bluff your way into motion detection with a webcam.
- 54 Designing and Making Basic Antennas**
It's surprisingly easy to make monopoles, dipoles and directional antennas for the 2.4 GHz ISM band.
- 60 Talk Show (ATM18 series)**
VRBot, SpeakJet and ATM18 are the main ingredients of an experimental voice synthesizer with a giant 1-pixel indicator thrown in for fun.
- 66 Unilab Duo**
Here we show how the Unilab bench PSU gets converted into a twin supply together with the September 2010 V/I readout.
- 69 Design Tips**
LED remote control for RC models
Simple IR remote control tester
- 70 Camera Interval Timer**
A fully programmable timer & multishot controller for photo cameras like the Canon EOS.
- 74 Light Tracker**
Very likely one of the simplest robotics circuits around that succeeds in finding light sources.
- 75 Hexadoku**
Our monthly puzzle with an electronics touch.
- 76 Retronics: Chauvin-Arnoux MF7 Precision Astatic Wattmeter**
Regular feature on electronics 'odd & ancient'. Series Editor: Jan Buiting
- 84 Coming Attractions**
Next month in Elektor magazine.

Elektor International Media provides a multimedia and interactive platform for everyone interested in electronics. From professionals passionate about their work to enthusiasts with professional ambitions. From beginner to diehard, from student to lecturer. Information, education, inspiration and entertainment. Analogue and digital; practical and theoretical; software and hardware.



**ANALOGUE • DIGITAL
MICROCONTROLLERS & EMBEDDED
AUDIO • TEST & MEASUREMENT**

Volume 36, Number 407, November 2010 ISSN 1757-0875

Elektor aims at inspiring people to master electronics at any personal level by presenting construction projects and spotting developments in electronics and information technology.

Publishers: Elektor International Media, Regus Brentford, 1000 Great West Road, Brentford TW8 9HH, England. Tel. (+44) 208 261 4509, fax: (+44) 208 261 4447 www.elektor.com

The magazine is available from newsagents, bookshops and electronics retail outlets, or on subscription. Elektor is published 11 times a year with a double issue for July & August.

Elektor is also published in French, Spanish, American English, German and Dutch. Together with franchised editions the magazine is on circulation in more than 50 countries.

International Editor:
Wisse Hettinga (w.hettinga@elektor.nl)

Editor: Jan Buiting (editor@elektor.com)

International editorial staff: Harry Baggen, Thijs Beckers, Eduardo Corral, Ernst Krempelsauer, Jens Nickel, Clemens Valens.

Design staff: Christian Vossen (Head), Ton Giesberts, Luc Lemmens, Jan Visser.

Editorial secretariat:
Hedwig Hennekens (secretariaat@elektor.nl)

Graphic design / DTP: Giel Dols, Mart Schroijen

Managing Director / Publisher: Paul Snakkers

Marketing: Carlo van Nistelrooy

Subscriptions: Elektor International Media, Regus Brentford, 1000 Great West Road, Brentford TW8 9HH, England. Tel. (+44) 208 261 4509, fax: (+44) 208 261 4447 Internet: www.elektor.com/subs

Elektor Personal Organizer 2011



Contents refill available separately

The Elektor Personal Organizer 2011 makes planning your appointments a real pleasure, and you always have ready access to have handy information that everyone who works with electronics needs to know.

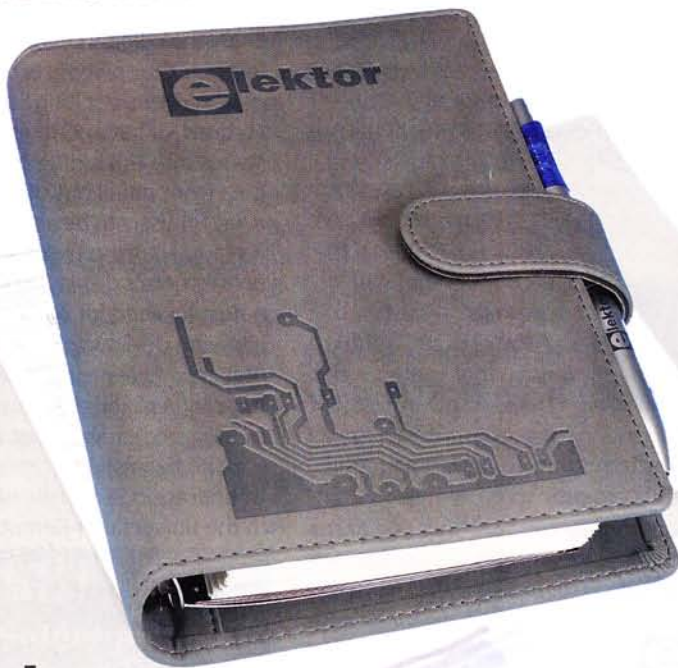

The Organizer 2011 at a glance:

- 2011 calendar (two pages per week)
- Appointments calendar (with corner perforations) in six languages
- 60 pages of technical information on electronics
- Seven sections, separated by tab sheets
- Alphabetic address and telephone book
- Handy monthly planner
- Lined pages for your notes
- Five credit-card pockets and a pocket for business cards
- Push-button closure
- Six-ring binder mechanism
- Luxurious grey imitation-leather binding
- Free pen and SMD Tool (with complete package only)

Contents refill 2011

If you purchased the Elektor Organizer last year, the content refill for 2011 can be ordered separately for £14.80 (US \$23.90).

ISBN 978-90-5381-259-4 • £24.90 • US \$40.20

Contains 60 pages of technical information on Electronics!

Further information and ordering at www.elektor.com/organizer

Email: subscriptions@elektor.com
Rates and terms are given on the Subscription Order Form.

Head Office: Elektor International Media b.v.
P.O. Box 11 NL-6114-ZG Susteren The Netherlands
Telephone: (+31) 46 4389444, Fax: (+31) 46 4370161

Distribution:
Seymour, 2 East Poultry Street, London EC1A, England
Telephone: +44 207 429 4073

UK Advertising:
Huson International Media, Cambridge House,
Gogmore Lane, Chertsey, Surrey KT16 9AP, England.
Telephone: +44 1932 564999, Fax: +44 1932 564998

Email: r.elgar@husonmedia.com
Internet: www.husonmedia.com
Advertising rates and terms available on request.

Copyright Notice
The circuits described in this magazine are for domestic use only. All drawings, photographs, printed circuit board layouts, programmed integrated circuits, disks, CD-ROMs, software carriers and article texts published in our books and magazines (other than third-party advertisements) are copyright Elektor International Media b.v. and may not be reproduced or transmitted in any form or by any means, including photocopying, scanning or recording, in whole or in part without prior written permission from the Publisher. Such written permission must also be obtained before any part of this publication is stored in a retrieval

system of any nature. Patent protection may exist in respect of circuits, devices, components etc. described in this magazine. The Publisher does not accept responsibility for failing to identify such patent(s) or other protection. The submission of designs or articles implies permission to the Publisher to alter the text and design, and to use the contents in other Elektor International Media publications and activities. The Publisher cannot guarantee to return any material submitted to them.

Disclaimer
Prices and descriptions of publication-related items subject to change. Errors and omissions excluded.

© Elektor International Media b.v. 2010 Printed in the Netherlands

World's first ultra-thin waterproof piezoelectric speaker

Featuring a thickness of only 0.9 mm, Murata has launched the world's first ultra-thin waterproof piezoelectric speaker. Based on Murata's proprietary piezoelectric technology, the speaker is waterproof to IPX5/IPX7. The speaker measures 19.5 by 14.1 by 0.9 mm; its rectangular shape reduces dead-space from designs while its ultra-thin dimensions contribute to greater freedom in equipment design.



Of the 50 new Japanese mobile phone models announced for 2010, almost one in four will be waterproof mobile phones, one of numerous indicators of a growing trend towards the waterproof-

ing of mobile equipment. Given there are so many different areas that require waterproofing, there were many technical challenges and cost issues to overcome when developing the waterproof speaker. Conventional methods of waterproofing dynamic speakers used waterproof sheets which covered the output sound holes, reducing sound quality. Murata's approach incorporates a rubber film into the speaker itself, leaving the output sound holes open. The width of the metal frame housing the speaker has been increased to improve the seal between the metal frame and the chassis, preventing water penetration.

The new waterproof speaker has been designated part number VSLBG1914E1400-T0. Its average sound pressure level (SPL) is 92.0 ± 3.0 dB (1500 Hz /2000 Hz/2500 Hz/3000 Hz average) with a resonant frequency of $1400 \text{ Hz} \pm 20\%$. Since no magnets are used, there is no possibility of malfunctions

caused by iron sand, or electromagnetic effects on magnetic sensors.

www.murata.eu (100639-IX)

Mainstream universal controller platform for RF and IR

The M-Remote from Audivo is the first mainstream universal RF remote control platform to complement RF with traditional IR capabilities, and offer a color (LCD or OLED) display. By using Nordic Semiconductor's nRF24LE1 2.4 GHz SoCs and Gazell RF software protocol, the M-Remote can seamlessly control the latest video and audio wireless streaming devices via bi-directional RF. The device also controls traditional IR-only equipped appliances such as TVs, set-top boxes (STBs), and A/V amps. Universal controllers have the ability to operate consumer electronics (CE) appliances

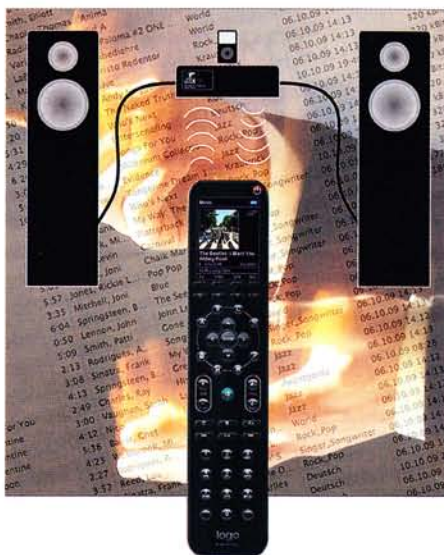

from different manufacturers eliminating the need for multiple dedicated remote controls. Until now, however, mass-market universal controllers have typically only employed traditional IR (infrared) technology.

The M-Remote OEM platform offers both RF and IR and targets consumer electronics (CE) manufacturers of the latest networked A/V devices such as streaming music servers, Internet radios and wireless multimedia centers. These appliances demand more advanced user interfaces than traditional push-button, one-way IR technology can support. RF offers the high-bandwidth, bi-directional wireless connectivity required to support more advanced user interface mechanisms such as scroll wheels, touch-screens, and track-balls. These are all designed to make it easier and more intuitive for end users to access and enjoy their digital content and services. This includes the ability to browse large libraries of stored music or long lists of Internet radio stations, or have continuous ('live') playing status info (including that usually shown on a front panel but often too small or far away for users to be able to see) and graphics (e.g. album artwork) displayed directly on a remote's display. In addition, RF eliminates the need for IR's line-of-sight access, allowing devices to be controlled through objects and even interior walls (usually up to a range of about 15m and assuming wall building materials do not excessively attenuate RF signals).

In operation, a Nordic nRF24LE1 located in the universal M-Remote communicates with a second nRF24LE1-based module embedded into the A/V networked streaming device using the Nordic Gazell software protocol. The Nordic nRF24LE1 utilizes a proven Nordic nRF24L01+ transceiver core and features an up to 2 Mbps on-air data rate combined with ultra low power (ULP) operation and advanced power management. The Gazell RF protocol provides features for advanced navigation, background data transfers (e.g. of larger files such as album artwork), and advanced pairing schemes, while being able to handle up to five remote devices at the same time. In addition, Gazell is a frequency agile protocol that is highly immune to interference from other 2.4 GHz radio sources such as Bluetooth wireless technology and Wi-Fi.

To conserve power, the M-Remote will typically enter an ultra-low power ($22 \mu\text{A}$) standby sleep mode when not in use (after 30 s in default mode, or between ten and 90 s if set by the user). This, however, is all hidden from the end user by the use of an

inbuilt motion sensor that means if the remote is picked up it activates a rapid power up (including the display) in 200 ms ready to respond immediately to any user input request. The M-Remote is able to offer over a week of operation before battery recharge. The fully customizable M-Remote is a complete solution including the remote control handset with integrated rechargeable lithium-ion (Li-ion) battery, charging cradle, host A/V device RF module, IR transmitter for standard devices (optional), API source codes (making it very easy to integrate the M-Remote platform into any modern A/V device), product design support, development kit, automatic pairing, and an optional touch (scroll) wheel. A full touchscreen could also be integrated if required, and multi-room (zone) control is also supported.

www.nordicsemi.com
(100639-VII)

Online IGBT selection tool

International Rectifier has introduced a new online Insulated Gate Bipolar Transistor (IGBT) selection tool that enables design optimization in a wide range of applications including motor drives, uninterruptible power supplies (UPS), solar inverters, and welding.



IR's new IGBT Selection Tool evaluates application conditions including bus voltage, switching frequency, and short circuit protection requirements. Located at mypower.irf.com/IGBT, the online tool provides an estimate of losses and suggests parts that can function within the given constraints. The tool also provides pricing for each part to enable designers to consider the effects of device choice on system cost. IR offers a broad array of IGBT products ena-

bling optimized inverter designs for different applications. The new online selection tool enables engineers to quickly and easily compare choices to select the optimal IGBT for their design.

IGBT selection requires evaluation of many parameters that cannot be simplified into a single metric. As switching losses can be traded for conduction losses, for example, calculating operating losses requires both operating frequency and bus voltage parameters, in addition to operating current. Also, the requirement of some motor drive inverters for minimum short circuit withstand time comes at the expense of higher losses.

IR offers a wide selection of IGBTs offering various tradeoffs in switching speed as well as devices designed for applications that do not have minimum short circuit requirements. The new selection tool helps designers make use of IR's broad IGBT portfolio and weigh the performance tradeoffs.

www.irf.com
(100639-X)

6GHz RMS power detector with digital output

Linear Technology introduces the LTC5587, an industry first 40 dB dynamic range 6 GHz RMS detector integrated with a high sampling rate 12-bit serial A/D converter. The digital output RMS RF detector provides ± 1 dB measurement accuracy of high crest-factor signals, independent of the modulation used. The detector is capable of operating over a wide frequency range from 10 MHz to 6 GHz. The integrated 12-bit ADC captures and digitizes the detector measurement at a rate of up to 500 ksamples/second and delivers the data via a bit

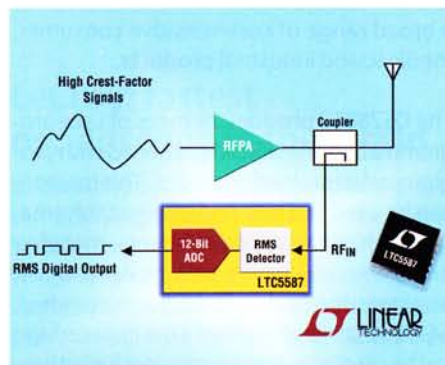

Vinculum VNC2 SPEED. FLEXIBILITY. PERFORMANCE.

A programmable system-on-chip
USB 2.0 Host / Slave controller

- Dual channel USB 2.0 interface, handles all USB host and data transfer functions in single IC.
- On-chip 16-bit Harvard architecture MCU core with 256 Kbyte Flash and 16kbyte RAM.
- External UART, FIFO, SPI Slave, SPI Master, GPIO and PWM interfaces.
- Vinculum-II software development tools available for user application development.
- Multiple package size options including VNC1L backwards compatible package option.
- Targeted for range of USB applications, from portable media devices and cell phones to industrial and automotive applications.

Vinculum-II evaluation modules

- V2DIP1/2 - Miniature VNC2 Development Module with Single or Dual USB Connectors
- V2-EVAL - Complete Evaluation & Development Kit for VNC2
- VNC2 Debug Module

VISIT US AT
ELECTRONICA 2010
Hall A5, Stand 351



USB MADE EASY
www.ftdichip.com



NEWS & NEW PRODUCTS

stream over a serial SPI port. The RF detector operates with single-ended input and requires no external balun transformer. Its small 3mm x 3mm DFN package provides a highly compact solution.

The LTC5587's ± 1 dB accuracy over a 40 dB dynamic range and over the full temperature range from -40°C to 85°C offers best-in-class performance. Combined with a 12-bit A/D converter, the device provides 0.014 dB per bit measurement resolution. Its low power consumption is ideal for applications in cellular basestations, picocells, and femtocells supporting all standards including LTE, W-CDMA, TD-SCDMA, CDMA/2k, GSM/EDGE and WiMAX. Other applications include MIMO radios, repeaters, point-to-point microwave links, military radios with complex modulation, remote power measurements, and portable test and measurement instruments. The detector is particularly useful in FPGA-based systems where no A/D converters are available. The LTC5587 is powered from a single 3.3 V supply. During sampling mode, its total operating current is 3 mA, consuming only 10 mW of power. Its consumption is further reduced by one-half when the ADC is idled, making the LTC5587 suitable for battery powered or portable remote RF measurement systems. The device also has shutdown capability, drawing less than 10 μA supply current when disabled. The LTC5587 is offered in a small 3mm x 3mm 12-pin DFN package, providing a compact solution footprint. The LTC5587 is available from stock.

<http://www.linear.com/5587>

Copy protection and license-management security over a single-contact interface

Maxim Integrated Products introduces the DS28E10, a challenge-and-response secure authentication IC that includes user-programmable nonvolatile (NV) memory. Authentication is implemented with the industry-proven FIPS 180-3 secure hash algorithm (SHA-1) combined with commands that operate on a programmable private secret and random challenge from a host controller. The device provides flexibility to implement private secret sizes from 64 bits to 288 bits; the host challenge size is 96 bits. These large secret and challenge

Farnell first to stock new Microchip development board

Farnell is the first European distributor to stock the new Microstick for dsPIC33F and PIC24H development board, which provides a complete, low-cost solution for designing with Microchip's

16-bit PIC24H microcontrollers and dsPIC33F Digital Signal Controllers (DSCs), in a compact 20x76 mm footprint. The low-cost Microstick offers an integrated USB programmer/debugger, which shortens learning curves. For maximum flexibility, the Microstick can be used stand-alone or plugged into a prototyping board.

Many engineers, educators, students and hobbyists need a low-cost solution for working with and debugging code on 16-bit microcontrollers and DSCs. In addition to its other benefits, the Microstick is populated with a socketed microcontroller that can be easily swapped out. The Microstick works with the PIC24HJ64GP502, which is the highest performance 16-bit MCU in the industry, and the dsPIC33FJ64MC802 DSC, which seamlessly blends DSP and MCU resources into a single architecture. Software support includes the same free MPLAB® Integrated Development Environment (IDE) and software libraries that work with all of Microchip's 8/16/32-bit PIC® microcontrollers and DSCs. Additionally, the dsPIC33F DSCs are supported by the free demo version of Microchip's Device Blocksets for the MATLAB® language and Simulink® environment, which work seamlessly within the MPLAB IDE.

This combination of low-cost tools and free software provides an industry-leading platform for experimentation and development of smart-sensor and a host of other embedded-control applications.

Through its industry-leading websites featuring tools such as Live Chat, and easily accessible data sheets, Farnell is able to support its electronics design engineering customers with information and ideas to help them select the most appropriate components and devices for their new designs. The element14 online engineering community provides a unique additional resource. Further information about the Microstick for dsPIC33F and PIC24H development board can be found at <http://www.element-14.com/community/docs/DOC-23484>.

www.microchip.com/get/EOKR www.farnell.co.uk (100639-XI)

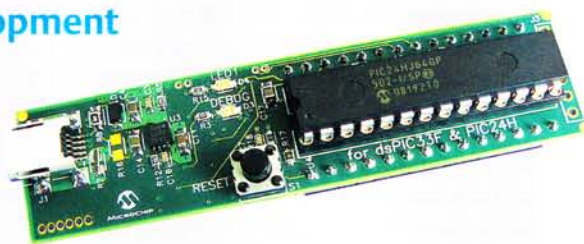

sizes make algorithmic brute-force attacks to discover the private secret mathematically impractical. Because die-level probe methods are the more likely method of security attack, the DS28E10 implements proprietary circuits and methods to protect sensitive data from being captured. This authentication solution is well suited for a broad range of cost-sensitive consumer, medical, and industrial products.

The DS28E10 provides 28 bytes of user-programmable OTP-EPROM ported with programmable protection modes. This memory can be used to store end-product information such as calibration constants, manufacturing data, and feature settings. Additionally, a unique, unalterable, factory-programmed, 64-bit serial number (ROM ID) is included and can be used as an input parameter for authentication

security functions and/or as a unique identifier for the end product.

Communication with the DS28E10 is implemented using Maxim's 1-Wire interface. The single-contact I/O interface enables the part to be easily added to a design from a spare microcontroller or FPGA port pin.



The DS28E10 operates from 2.8 V to 3.6 V and is fully specified over the -40 degrees Celsius to +85 degrees Celsius extended temperature range. It is available in small, 3-pin SOT23 and 6-pin TSOC packages. An evaluation kit (DS28E10EVKIT+) is also available to assist with end application development and to program device memory.

www.maxim-ic.com/DS28E10
(100639-XIII)

Tinytag current/voltage loggers

The new battery-powered 1-channel data loggers with 16-bit resolution have a rugged housing with LCD display of the current readings. There is the model TV-4704 available with an input voltage range of 0-25 VDC and a resolution of 1 mV, as well as the model TV-4804 with the input current range of 0-25 mA DC and a resolution of 1 µA.

With the above mentioned current and voltage ranges a variety of industry standard sensors and transducers can be connected, which enables the recording of a wide range of process and environmental parameters. The devices have a memory capacity of 30,000 readings and the housing protection is rated at IP67. They are supplied with an input connection cable.

The optional data logger software enables the scaling of the readings, that means, during the evaluation of the signals the real values of the connected sensors as well as the suitable physical units can be displayed. There are user-programmable sampling intervals between 1 s and 10 days and two programmable alarms available, and there is also an option for delayed start up to 45 days, direct start via reed switch and three stop functions (when memory is full; after n

readings or overwrite oldest data). After the run is finished, the stored data can be transferred to a computer via an interface cable, and they can be displayed as a curve or spreadsheet, printed or processed in other applications.

www.priggen.com
(100-XII)

IPS for servo motor controllers

Images Scientific Instruments Inc. new IPS (Integrated Power Supply) is setting the new standard of excellence in servomotor controllers. Our line of servo motor controllers allows you to use a variety of inexpen-



sive power supplies to run both your controller board and servomotors. Use available power supplies; transformers, batteries, wall transformers, etc. anything from 6V to 30V either AC or DC. The IPS system will regulate the power to run your servomotors efficiently. Power is supplied through 2.5 mm power socket on board. A discrete 2.5 mm power jack is provided with our controllers for connecting your own power supply.

The picture shows the newest products in the Servobotics line of servo motor controllers; starting at the upper right and moving clockwise; the PS2-SMC-06, USB-SMC-05, USB-SMC-4 and USB-SMC-08.

<http://www.imagesco.com>
(100708-I)

LeCroy: fastest oscilloscope in the world

LeCroy Corporation's new line of WaveMaster 8Zi-A digital oscilloscopes — the 8 Zi-A Series — now provides up to 45 GHz of bandwidth and 120 GS/s of sample rate — the world's highest bandwidth and fastest sample rate real-time oscilloscope — combined with 768 Megapoints of analysis memory.



Temwell Innovative - 3 & 4 tuning tunable BP Filter UHF Helical SMD Pin Type BandPass Filter

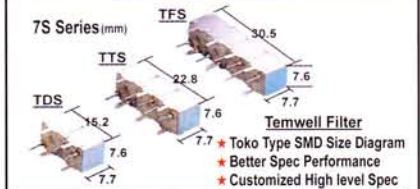

Pass Band	2 Tuning (7S2 series)		3 Tuning (7S3 series)	
	Temwell-P/N-Fo-BW	IL	Temwell-P/N-Fo-BW	IL
221-245M	TDS-2012B-230M-14M	3.5	TTS-3012B-230M-14M	5.0
246-275M	TDS-2024F-268M-15M	4.0	TTS-3025B-268M-14.5M	4.5
276-310M	TDS-2034F-300M-19M	4.0	TTS-3034F-300M-19M	5.0
311-350M	TDS-2045B-314M-10M	3.5	TTS-3044B-338M-19M	3.5
311-350M	TDS-2046F-314M-22M	2.0	TTS-3046F-314M-22M	3.0
351-400M	TDS-2053F-375M-13M	4.0	TTS-3055B-375M-12M	5.0
351-400M	TDS-2054F-375M-20M	3.0	TTS-3056F-375M-20M	5.5
401-455M	TDS-2068B-420M-15M	3.0	TTS-3068B-420M-16M	4.5
401-455M	TDS-2067B-440M-19M	3.0	TTS-3064F-434M-42M	3.0
456-515M	TDS-2075B-460M-16M	3.0	TTS-3076B-470M-18M	4.5
456-515M	TDS-2072B-485M-37M	3.5	TTS-3072C-485M-29M	4.0
516-555M	TDS-2084B-530M-18M	4.0	TTS-3083C-535M-37M	4.0
556-595M	TDS-2094D-580M-17M	2.5	TTS-3094D-580M-15M	3.5
596-640M	TDS-2104D-614M-20M	3.0	TTS-3104D-614M-14M	3.5
596-640M	TDS-2101A-614M-31M	3.5	TTS-3101A-614M-31M	4.5
641-660M	TDS-2114A-650M-19M	2.5	TTS-3124A-680M-17M	4.0
661-700M	TDS-2124D-680M-21M	2.0	TTS-3124D-680M-21M	3.0
701-750M	K2SD-750M-20M-20M	3.0	K3SD-750M-20M-20M	4.0
751-800M	TDS-2147A-775M-50M	1.5	TTS-3147A-775M-49M	2.0
751-800M	TDS-2144A-800M-22M	3.0	TTS-3144A-800M-21M	3.5
801-830M	K2SD-810M-20M-20M	3.0	TTS-3154A-815M-52M	4.0
831-860M	K2SD-840M-20M-20M	3.0	TTS-3164A-850M-22M	5.0
831-860M	TDS-2162A-845M-68M	2.0	TTS-3162A-845M-62M	2.0
861-880M	K2SD-870M-20M-20M	2.5	TTS-3174A-870M-18M	5.5
881-900M	TDS-2184A-890M-22M	3.0	TTS-3184A-890M-17M	5.5
881-900M	K2SD-900M-20M-20M	3.0	K3SD-900M-20M-20M	4.0
901-930M	K2SD-930M-20M-20M	3.0	TTS-3191A-915M-86M	2.0
931-950M	TDS-2204A-940M-23M	3.5	TTS-3204A-940M-23M	4.5
951-975M	TDS-2212A-958M-25M	2.5	TTS-3215A-960M-17M	5.0
951-975M	K2SD-960M-20M-20M	3.0	TTS3213A-962M-60M	3.5
976-1000M	TDS-2224A-997M-29M	3.0	TTS-3221A-987M-56M	2.5
1001-1050M	TDS-2233A-1025M-65M	2.5	TTS-3233A-1025M-65M	3.5
1051-1100M	TDS-2241A-1075M-64M	3.5	TTS-3241A-1075M-64M	4.5
1101-1250M	TDS-2243A-1125M-64M	2.0	TTS-3261A-1170M-21M	4.5
1101-1250M	TDS-2245A-1225M-68M	2.5	TTS-3243A-1125M-60M	3.0
1251-1300M	TDS-2274A-1270M-37M	3.0	TTS-3274A-1270M-32M	3.5
1301-1350M	TDS-2246A-1275M-76M	2.0	TTS-3246A-1275M-76M	3.0

Biggest-WebShop-VHF UHF Standard BandPass Filter Temwell&Toko Type: Alternative online- 72hr Shipping Total 200Kpcs, 500 models, 2&3 tuning In-Stock

① 7HW/7HT Toko 302MXP Type UHF (2/3 Tuning Filter)			
TW-P/N-Fo-BW	TW-P/N-Fo-BW	TW-P/N-Fo-BW	TW-P/N-Fo-BW
K2B1-360M-10M	K2B1-405M-13M	K3B1-435M-20M	K3CT1-833M-21M
K2B1-370M-10M	K2B1-425M-13M	K3B1-455M-20M	K3B1-835M-20M
K2B1-380M-10M	K3B1-370M-10M	K3B1-465M-15M	K3CT1-865.5M-23M
K2B1-390M-10M	K3B1-370M-10M	K3B1-485M-20M	K3B1-860M-25M
K2B1-410M-10M	K3B1-390M-10M	K3B1-510M-15M	K3CT1-904M-12M
K2B1-420M-11M	K3B1-390M-16M	K3B1-510M-12M	K3CT1-915M-12M
K2B1-435M-11M	K3B1-410M-11M	K3CT2-600M-20M	K3CT1-938M-15M
K2B1-450M-11M	K3B1-410M-16M	K3B1-612M-18M	K3CT1-947M-18M
K2B1-460M-11M	K3B1-415M-16M	K3CT2-651M-10M	K3CT1-960M-12M
K2B1-475M-11M	K3B1-415M-20M	K3B1-680M-13M	K3CT1-1015M-25M
K2B1-490M-13M	K3B1-425M-20M	K3CT1-833M-16M	
② 7HW Toko 252MXP Type UHF (2 Tuning Filter)			
TW-P/N-Fo-BW	Toko P/N	TW-P/N-Fo-BW	Toko P/N
K2B-405M-20M	252MXP-2735A	K2B-453M-20M	252MXP-2767A
K2B-435M-20M	252MXP-2737A	K2B-480M-20M	252MXP-2765A
③ 5HW Toko type UHF Double Tuning Band Pass Filter			
TW-P/N-Fo-BW	TW-P/N-Fo-BW	TW-P/N-Fo-BW	TW-P/N-Fo-BW
K2RB-365M-10M	K2RB-474M-11M	K2RB-670M-20M	K2RB-958M-25M
K2RB-380M-10M	K2RB-475M-11M	K2RB-700M-20M	K2RB-1010M-26M
K2RB-415M-10M	K2RB-505M-14M	K2RB-735M-20M	K2RB-1130M-26M
K2RB-425M-10M	K2RB-530M-14M	K2RB-820M-20M	K2RC1-1195M-35M
K2RB-430M-10M	K2RB-545M-14M	K2RB-880M-20M	K2RC-1225M-35M
K2RB-450M-11M	K2RB-625M-14M	K2RB-914M-25M	K2RC-1305M-35M
④ 5HT Toko type UHF Triple Tuning Band Pass Filter			
TW-P/N-Fo-BW	TW-P/N-Fo-BW	TW-P/N-Fo-BW	TW-P/N-Fo-BW
K3RFT-360M-20M	K3RFT-460M-18M	K3RBT-655M-16M	K3RBT-945M-20M
K3RFT-380M-20M	K3RFT-480M-18M	K3RBT-705M-20M	K3RBT-980M-20M
K3RFT-400M-15M	K3RFT-495M-20M	K3RBT-735M-20M	K3RBT-1010M-20M
K3RFT-410.7M-10M	K3RFT-515M-20M	K3RBT-800M-20M	K3RBT-1055M-20M
K3RFT-420M-16M	K3RFT-518M-20M	K3RBT-830M-20M	K3RBT-1090M-20M
K3RFT-435M-10M	K3RFT-520M-14M	K3RBT-862M-20M	K3RBT-1125M-20M
K3RFT-440M-18M	K3RFT-590M-18M	K3RBT-880M-20M	K3RBT-1230M-20M
⑤ 7HW/7HT Temwell type VHF 138-260MHz (2&3 Tuning Filter)			
TW-P/N-Fo-BW	TW-P/N-Fo-BW	TW-P/N-Fo-BW	TW-P/N-Fo-BW
TD67194B-140M-9M	TD6732B-220M-8M	TD6711B-160M-10M	TD6763B-240M-12M
TD67261B-160M-8M	TD6734B-240M-8M	TD67193B-180M-12M	TD6764B-260M-12M
TD6730B-180M-6M	TD6737B-260-10M	TD6761B-200M-11M	
TD6732B-200M-8M	TD6767B-140M-13M	TD6761B-220M-11M	

[Welcome Worldwide Partner]
★ Call Temwell or our distributors in UK ★
Taiwan Office (Taipei): 8:30am-5:30pm (Open)
Tel: +1-914-410-8773 (GMT+8 hours)
EuroQuartz Limited Tel: +4-1460-230000
BEC Distribution Tel: +44-8454-900405
TEMWELL CORPORATION
Made in Taiwan/ Designer & Manufacturer & Exporter
www.temwell.com.tw / Mail: joe@temwell.com.tw

New boards galore from mikroelektronika

Mikroelektronika have released a number of new boards to the microcontroller/embedded markets.

The **SmartTM1 Board** allows users to use Teltonika TM1 module in their GSM/GPRS application design. The tool supports Teltonika TM1 GSM/GPRS module and has on-board voltage regulation, so there is no need for additional power supply circuit. All you need to do is to connect power supply to the board, attach a GSM antenna and you are ready for your device designing. Each feature of the board is supported by example written in mikroC, mikroPascal and mikro-Basic PRO compilers.

The new **XMEGA-Ready** is a full-featured prototype board that contains ATxmega128A1 device (it is connected to 8MHz oscillator). It also features a USB support via FT232R. This tool is ideal for exploring and designing devices using new Atmel® XMEGA™ A1 family.

The development tool called **mikroXMEGA** is a small-package prototype board with ATxmega128A1 device (running at 8 MHz). This tool contains the FT232R (USB to serial UART interface) that can be



easily connected to a PC. Now you can explore the new Atmel® XMEGA™ A1 family at a low price.

The **EasyPULL board** contains 8 pull-up resistors (10 kΩ or 1 kΩ option). It can be used to fix an input pin to a known state if no input is present. On-board jumpers set pull-up/pull-down resistors for each pin

connected to your prototype device. Also new is the **EasyWiFi Board** — a full-featured add-on tool for development of devices that use 2.4 GHz wireless communication. It features the ZeroG ZG2100M module that provides fast data transmission and a wide data range. The board can be connected to your system or microcontroller via IDC10 connectors. Besides this, the tool features voltage translators which allows tool to work on both 3.3 V and 5 V voltage systems.

Finally there's the **EasyLED Board**. This tool features eight LEDs that can be used for visual indication of output signals. Also, it can be connected to external electronic circuits via IDC10 connector and extension pins. The board is ideal for embedded projects that need some kind of visual indication, which can be used for signal monitoring purposes.

www.mikroe.com
(100708-II)

Additionally, the introduction of a model with 20 GHz of bandwidth on four channels provides the highest performance and signal fidelity available on four measurement channels. On all models, acquisition capability can be doubled with the use of the Zi-8CH-SYNCH Oscilloscope Synchronization Kit, with all acquired channels displayed on a single display grid. The standard sample rate is 120 GS/s for 45 GHz bandwidth, 80 GS/s for 25 to 30 GHz bandwidths, and 40 GS/s on all 4 channels at 20 GHz bandwidth. For 4 to 20 GHz bandwidths, the standard sample rate is 40 GS/s on all four channels with an option to increase the sampling rate to 80 GS/s on two channels. All memory is available at full record lengths for analysis processing, 20 Mpts/ch is provided standard, with memory options up to 256 Mpts/ch available. In 120 and 80 GS/s mode, memory can be interleaved to 768 and 512 Mpts/ch.



The WaveMaster 8Zi-A models utilize second generation silicon germanium (SiGe) components to ensure high performance. SiGe is the most widely adopted and deployed semiconductor fabrication process with many years of commercial deployment. Additionally, it has none of the ther-

mal conductivity, reliability, yield, cost and other concerns that captive in-house processes must contend with. LeCroy's 30 to 45 GHz 8Zi-A models make use of sixth generation Digital Bandwidth Interleave (DBI) to effectively and reliably extend bandwidth without the deleterious effects of bandwidth "boosting".

LeCroy has designed the 8 Zi-A Series as a single hardware platform, supporting all nine models spanning from 4 to 45 GHz of bandwidth. This means engineers can leverage their investment and stay current with emerging high-speed technologies and serial data standards by purchasing only the

bandwidth needed for current designs, and upgrading to additional bandwidth as needs change. Customers who had previously purchased an 8 Zi model can upgrade to 8 Zi-A performance and bandwidth.

www.lecroy.com
(100708-III)

Low-Power Microcontrollers for Battery-Friendly Design

Microchip Offers Lowest Currents for Active and Sleep Modes



Microcontrollers

Digital Signal
Controllers

Analog

Memory

Extend the battery life in your application using PIC® microcontrollers with nanoWatt XLP Technology and get the industry's lowest currents for Active and Sleep modes.

Microchip's new peripheral-rich PIC12F182X, PIC16F182X and PIC16F19XX families offer active currents of less than 50 μ A and sleep currents down to 20 nA. These products enable you to create battery-friendly designs that also incorporate capacitive touch sensing, LCD, communications and other functions which help differentiate your products in the marketplace.

Microchip's Enhanced Mid-range 8-bit architecture provides up to 50% increased performance and 14 new instructions that result in up to 40% better code execution over previous-generation 8-bit PIC16 MCUs.

PIC12F182X and PIC16F182X families include:

- Packages ranging from 8 to 64 pins
- mTouch™ capacitive touch-sensing
- Multiple communications peripherals
- Dual I²C™/SPI interfaces
- PWM outputs with independent time bases
- Data signal modulator

PIC16F19XX family includes:

- mTouch capacitive touch-sensing
- LCD drive
- Multiple communications peripherals
- More PWM channels, with independent timers
- Up to 28 KB of Flash program memory
- Enhanced data EEPROM
- 32-level bandgap reference
- Three rail-to-rail input comparators

GET STARTED IN 3 EASY STEPS

1. View the Low Power Comparison videos
2. Download the Low Power Tips 'n Tricks
3. Order samples and development tools

www.microchip.com/XLP



PIC16F193X 'F1' Evaluation Platform - DM164130-1

Intelligent Electronics start with Microchip

microchip
DIRECT
www.microchipdirect.com

www.microchip.com/xlp

 **MICROCHIP**

Introducing mbed

Ready to start prototyping the mbed way? Here you learn how mbed's co-creator Simon Ford took the design from concept to creation! The mbed microcontroller and tools now make rapid prototyping a cinch.



By Simon Ford (UK)

When Circuit Cellar and Elektor approached me about running a "design challenge" around mbed, I saw an opportunity to do something special. Bringing together the mbed platform we've been developing and a gaggle of innovative engineers should be a recipe for some great results! We're setting out to help make the microcontroller world a better place by laying down a very specific, yet wide-ranging, challenge: What technology can you help unlock for your fellow innovators?

I grew up on magazines like Circuit Cellar and Elektor, and many of my early experiments were inspired by the projects people had sent in. A few years on, I wrote a couple of articles about projects I had designed, and got them published too.

My hope was that the articles would serve to inspire my comrades in the same way. I was still at school at the time, so getting paid to do my hobby was a huge novelty. Interestingly, it is a novelty I have managed to keep going at ARM, and one that I plan to continue! The point: progress is all about standing on the shoulders of giants, but sometimes I wonder if the embedded world missed that memo.

I started mbed as a skunk works project with Chris, a friend from work. We were both volunteering, trying to help people with microcontroller projects, and it was really painful. You can only make so many excuses for the tools, processes, and general fiddliness until you have to step back and ask, "Why does it have to be so hard?" That led to many evenings of research and experiments to understand how we could help people get stuff done. Fast forward a few years and it has become an official ARM project and we've grown an excellent team that is making the idea a reality. But what makes me really proud is the great community springing up around it; everyone has been incredibly supportive of each other, and it is a nice reminder that engineers are fundamentally enthusiastic, inventive, selfless, and helpful.

If you haven't already seen what we are up to, take a look at <http://mbed.org>. The mbed Microcontroller is the hardware component,

taking a top-end ARM microcontroller and packaging it in a 0.1" pitch form factor with built-in USB programmer. The mbed Compiler aims to simplify tools too, making them accessible online just like webmail, so it "just works." And the developer website we're building is helping to provide the support, the resources, and the tools to allow you to share your developments, programs, libraries, and write-ups to help others get the next job done faster. This is where the challenge really kicks in.

We're looking for you to collectively enable as much technology as possible: get components talking, create a killer library, build an innovative reference design, or invent some form of interesting product prototype. This basically means anything that can be shared on <http://mbed.org> and reused by the next person to inspire and build their prototypes even faster. In reality, this is less of a competition against other developers (although that is very much encouraged!) than it is a challenge against the stranglehold of complexity and obscurity that hangs around microcontroller technology.

I'll be at Elektor Live! in Eindhoven, The Netherlands, on November 20, 2010. So, if you are around, please track me down and say hello. It would be great to hear your plans, problems, and progress first hand.

The most successful projects are ones where you scratch your own itch. Our itch was a full-on allergic reaction to all the barriers to prototyping with microcontrollers. We've tried to get things moving, and I hope you'll take up the challenge to join us. So, get yourself an mbed, get involved in the design challenge, and get building the foundations for enabling the products of the future. Help us set embedded technology free!

(100617)

Simon Ford, co-creator of mbed, is a lifelong electronics and computer engineer. He works at ARM, and before starting mbed was technical lead for the ARMv7/NEON architecture now found in most new smartphones.



To enter the NXP mbed Design Challenge 2010, go to: www.circuitcellar.com/nxpmbeddesignchallenge/

01279 Credit Card Sales **467799**



Ho! Ho! Ho! Christmas 2010 is on it's way but
DON'T PANIC!!
We have some fantastic gift ideas for young (and old) enquiring minds



Electronic Project Labs

An electronics course in a box! All assume no previous knowledge and require NO solder. See website for full details



Robot Sensor - £21.95
Order Code EPLR20KT



Electronic Bell - £8.95
Order Code EAKEBKKT



Trainmech—£13.95
Order Code C21-606KT

Robot & Construction Kits

Future engineers can learn about the operation of electronics, robotics and transmissions systems.



Digital Recording Laboratory - £34.95
Order Code EPLDRKT



Electronic Motor - £8.95
Order Code EAKEMKT



Hyper Peppy - £23.95
Order Code MR969E



Tyranomech - £12.95
Order Code C21-601KT



30 in ONE - £19.95
Order Code EPL030KT

Solderless Electronic Project Kits



130 in ONE - £49.95
Order Code EPL130KT



Generator - £8.95
Order Code EAKEGKT



Line Tracker - £49.95
Order Code 4021KT

Festive Electronic Project Kits



AM / FM Radio Kit - £11.95
Order Code ERKAFKT



Room Alarm - £4.95
Order Code EAKRAKT



Musical LED Jingle Bells - £17.95
Order Code 1176KT



300 in ONE - £89.95
Order Code EPL300KT



Short Wave Kit - £11.95
Order Code ERKSWKT



Hand Held Metal Detector - £9.95
Order Code ELMDX7



Air Shooter - £39.95
Order Code 4025KT



Flashing LED Christmas Tree - £7.95
Order Code MK100KT



500 in ONE - £199.95
Order Code EPL500KT



Crystal Radio Kit - £8.95
Order Code ERKCKT



Metal Detector - £9.95
Order Code ELMDKT



Running Microbug - £12.95
Order Code MK127KT

Go online for
Special Offers

See our website
for even more
great gift ideas!



www.QuasarElectronics.com

Secure Online Ordering Facilities • Full Product Listing, Descriptions & Photos • Kit Documentation & Software Downloads



What's That in the Air?

By Rolf Blijleven (The Netherlands)

Detection and analysis of gasses is a requirement for numerous branches of industry and science, from petrochemical to medical instrumentation. In this article we discuss the theory and methods of real-time gas measurements of two important groups: oxygen and hydrocarbon compounds.

All real-time gas analysers measure partial pressure. The reading you take from a barometer is actually nothing more than the weight of the molecules in the air around us. Dry air consists of 78.02% nitrogen (N_2), 20.94% oxygen (O_2), 0.04% carbon-dioxide (CO_2) and a small amount of noble gasses and water vapour. All together, these gasses at sea level add up to a pressure of 760 mm Hg = 101.3 kPa = 1.01 bar. At higher altitudes the density of the air is less and the pressure reduces. When the weather is nice the total pressure increases — that's the high-pressure region that the weatherman always talks about. Unless there is a severe frost, the air is usually not dry, but has a certain humidity, which is usually expressed as a Relative Humidity (RH) in percent.

Principles of gas measurements

Before the gas can be measured, steps have to be taken to prevent water vapour from being included. In addition, you don't want the gas in the analyser to be stationary: you are usually interested in changes of the gas concentrations. That is why gas analysers nearly always take samples using a sample-pump, which draws the gas through the analyser. Furthermore, an analyser needs to be calibrated and you are usually also interested in the flow rate through the analyser, so that you can calculate the *concentration* of the measured gas. **Figure 1** shows the diagram of a typical gas analyser. At the far right is the sample-pump, which draws the gas through the analyser. A pressure sensor is connected with a T-coupling in front of the analyser. This measures the barometric pressure when the sample-pump is off. You need to know this so that you can calculate the partial pressure. When the sample-pump is on, the sensor gives an indication of the flow rate through the analyser(s).

Moisture problem?

Before the gas enters the analyser, it passes through a sample tube. These things come in different variations. Sometimes it is a column of anhydrous (containing no water) calcium sulphate, which absorbs

all water vapour. In other cases it is a cooling chamber, which ensures that the water vapour condenses and which can then be drained as liquid water. A third, very common method uses Nafion, a derivative of Teflon, which has a very high permeability to water. Make this into a tube and the tube will then ensure that the concentrations of water molecules on the inside and outside are nearly identical.

An analyser is usually calibrated in two places: zero and range, that is, at the zero point and at the upper limit of the measuring range. This requires two bottles of calibration gas, the gas concentrations of which are accurately known. First one and then the other calibration gas is sent through the analyser. The gas that comes from the bottle has an RH = 0%. At the end of the sample tube this dry gas is humidified to the RH in the room: ambient, in jargon. After the calibration, the sampling is switched to the measuring input. When you measure air from the room, the RH does not change, ambient remains ambient. When you measure gas with a higher RH, such as exhaled gas, then at the end of the sample tube that gas has dried out and again has the same RH as the ambient. The analyser therefore always 'sees' a gas with the same humidity, so this uncertainty is now eliminated from the measurement!

In some cases it is sufficient to have only one calibration gas. When calibrating oxygen, we can assume that the ambient air contains 20.94% O_2 . This number is virtually constant across the entire world, thanks to the production of oxygen by tropical forests and oceans. However, this is certainly not true for CO_2 . After a day in a meeting room with all the windows closed the amount of CO_2 can easily increase to one percent.

Sufficiently fast and sensitive?

Gas analysers are usually not fast, a speed of response measured in minutes is not at all unusual. For some applications — such as the three-gas measurement for the annual car certification — this is not a problem. In other cases, a response time shorter than 150 millisec-

Real-time gas measurements with special sensors

onds is a necessity, monitoring anaesthetics is an example. While it is possible to design analysers with improved response time this is sometimes still not sufficient. The solution is software, the operating principle is outlined in **Figure 2**. With a step-change of input signal, the response time is generally accepted as being the time (t_1) required for the output to reach 90% of the full swing. But you can also just sample the beginning of the output signal as soon as it starts to increase and based on the rate of change in that region estimate what the final value will be. Response times in the order of 90 ms are possible. Pure guesswork? It is not that bad: the result of this 'guess' can be verified during the calibration. The disadvantage of this method is that the equipment usually has to be calibrated before each measurement.

As most readers will know already, the sensitivity of gas analysers is usually expressed as parts per million, ppm. One litre of water (1 kg) polluted with 1 milligram of lead has a lead concentration of 1 ppm.

With this basic knowledge let's take a look at a few types of practical gas analysers.

Oxygen

Electrochemical gas sensors have been around since the 1950s. The operating principle is illustrated in **Figure 3**. The gas is pumped through the top of the cell past a membrane and diffuses through it into an electrolyte. The membrane is hydrophobic, literally 'scared of water', and ensures that the electrolyte does not leak out. At the bottom of the electrolyte is an anode made from lead (Pb) or cadmium (Cd) which oxidises. This releases electrons, which travel to the cathode via an external circuit, where they are consumed by the oxygen molecules. The chemical reactions are as follows. With an acidic electrolyte:

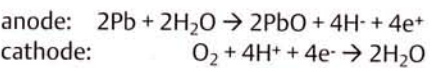

and with an alkaline electrolyte:

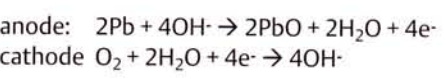

The total reaction in both cases is: $2Pb + O_2 \rightarrow 2PbO_2$. The oxidising reaction consumes the anode material, so this type of cell will not last forever. If the sensor is continually exposed to high oxygen concentrations then its life expectancy will be shortened.

There is a lot of choice in oxygen cells. The life expectancy of most cells is around one and a half to two years, but, for example, the KS-50 from the Japanese JS Yuasa [1] has an extremely long life expectancy of 10 years at 21% O_2 and 20° C. The response time is quite slow at 60 s, response times of 6 to 10 s are more usual [2]. Teledyne calls its A-1, for industrial applications, with less than 4 s, ultra fast [3], but for medical application Teledyne can also supply the UFO-130-2 (**Figure 4**), which at 130 ms is another 30 (!) times faster. A measuring range of 0 to 100% O_2 is typical, but a smaller range, from 0 to 30% is also common.

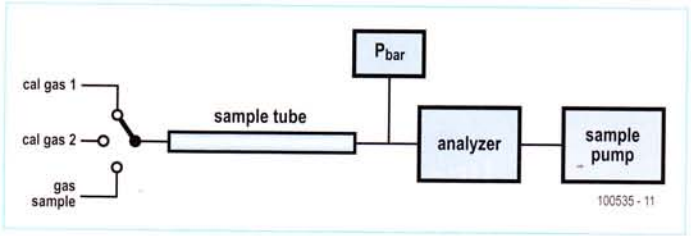

Figure 1. Functional diagram of gas detection.

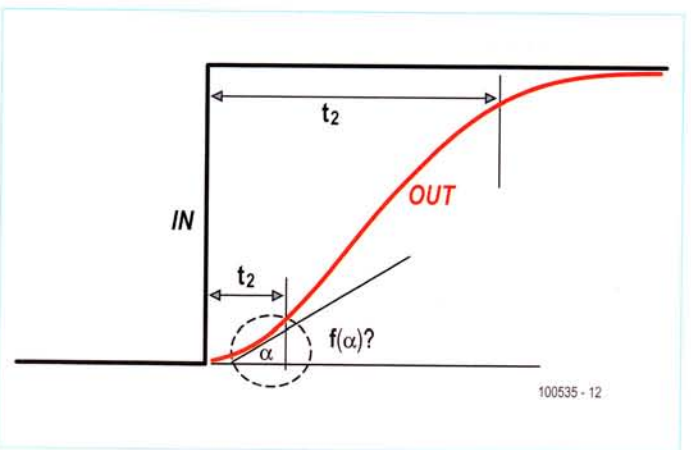

Figure 2. By measuring the shape of the slope at the start of the rise time the response time can be improved.

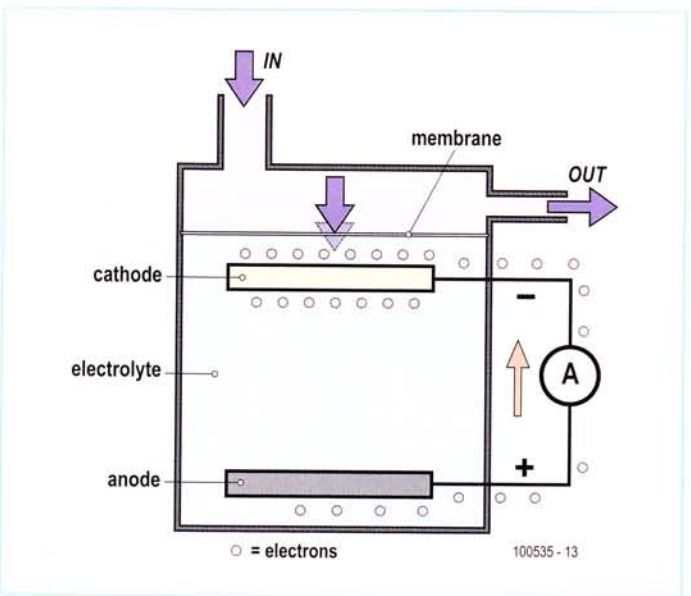

Figure 3. Functional schematic of an electrochemical oxygen cell.

GAS DETECTION



Figure 4. The UFO-130-2 oxygen sensor from Teledyne has a very short response time of 130 ms (photo: Teledyne).

Hydrocarbons and family: non-dispersed infrared

Gas molecules consist of atoms. **Figure 5** shows a carbon-dioxide atom (CO_2), but such a picture also applies to carbon-monoxide (CO), nitrogen-dioxide (NO_2), nitrogen-monoxide (NO), ozone (O_3), methane (CH_4), sulphur-dioxide (SO_2), etc. The bond between atoms has one or more resonant frequencies which are a characteristic of a particular molecule and so for the gas of interest.

Infrared (IR) is a generic term for radiation with a wavelength of $0.75 \mu\text{m}$ near the visible red light up to about $1000 \mu\text{m}$ for far infrared (FIR). Heat radiation or thermal IR has a wavelength of about 3 to $15 \mu\text{m}$.

When a gas is radiated with infra red energy in that spectrum, then gas molecules will absorb energy at their characteristic resonant frequencies. At the other end of the gas we detect the remaining IR-energy. From the frequencies that are no longer present, follows which gas has been detected.

The generation of radiation with a frequency range of 3 to $15 \mu\text{m}$ is possible using bundled infrared light which passes through a prism, so that the radiation is dispersed into a range of wavelengths. This is called dispersed infrared, but is not very common in practice. Non-dispersed infrared (NDIR) is by far the most common method of IR-detection, the principle of which is illustrated in **Figure 6**.

At the far left is the IR-source. This can be a simple IR-LED, an incandescent lamp that gives off a little heat, or a special IR-source [4]. This light passes through the gas in the sample cell, at the other end of which is the detector. Filter B, usually made from coloured glass, forms a band-pass filter, the centre frequency of which is equal to that of the gas to be detected. This filter can also be placed in front of the IR-source, in the position of filter A.

The gas sample normally also contains other gasses which also absorb a small amount of IR, but we do not want to detect those. The absorption spectra of CO and CO_2 are right next to each other (**Figure 7**). Say we want to measure CO , but the gas sample also contains CO_2 and the combination of detector and band-pass filter is not selective enough. A solution is to place a block of 100% CO_2 after the IR-source, in the position of filter A. This acts as a steep band-stop filter: all IR-energy that the CO_2 can absorb is completely absorbed before the radiation enters the sample cell; how much CO_2 that contains is now no longer relevant. In this way the detector contains a signal related only to CO .

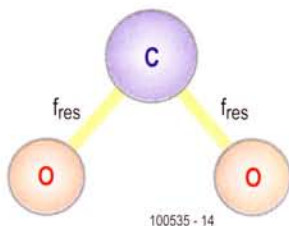

Figure 5. A CO_2 molecule.

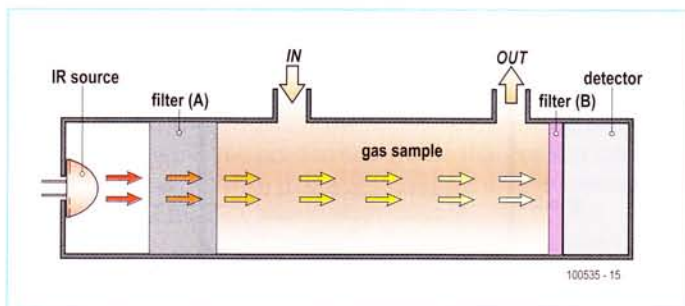

Figure 6. The principle of infrared gas detection (see text).

All gas analysers have unavoidable problems with fluctuation of the zero point (zero drift). In addition, the signal from the gas is buried deep in noise — not unexpected if you want to measure 0.3% gas. The most popular solution for this is shown in **Figure 8**. The chopper is a rotating disk with a hole in it. An IR-beam passes through this hole onto the concave mirror on the left, and in turn through the sample-cell followed by the reference cell. By subtracting one signal from the other it is possible to automatically compensate for zero drift and eliminate the noise. Furthermore, the IR radiation takes a longer path, which results in greater absorption and improves the signal.

Because of all the mechanical parts such an analyser is quite sizeable, count on a box of about $20 \times 10 \times 10 \text{ cm}$. Thanks to mathemati-

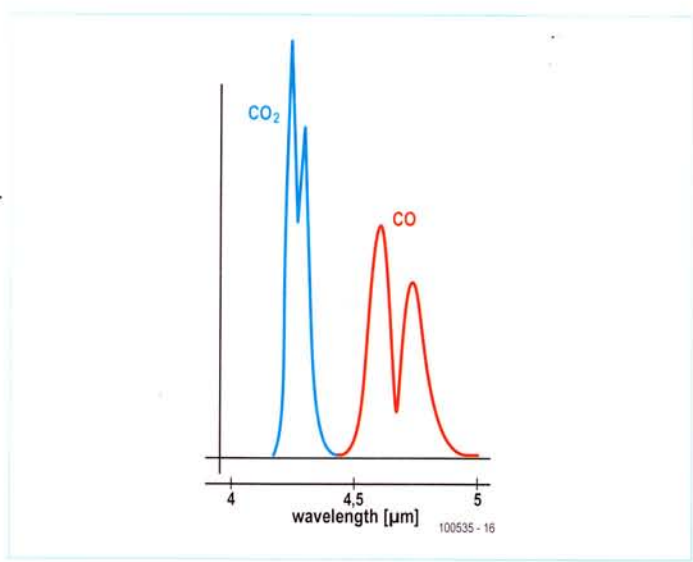

Figure 7. The absorption spectra of CO and CO₂ are right next to each other.

cal noise reduction and fast Fourier analysis (FFT, Fast Fourier Transform) the chopper and reference cell can be omitted. Miniature versions of the design of **Figure 5** are now possible, such as the ZG-01 and ZG02 IR modules from ZyAura [7] (**Figure 9**), which we used in our CO₂ monitor in the May 2010 edition of Elektor. The Japanese Shinyei uses the principle of IR detection in integrated detectors for dust particles and pollen [5], fully integrated with sample-pump and measuring cell on a board measuring about 6 by 5 cm (see **Figure 10**).

And those are not the only ones. ICx Technologies came in 2006 with the SensorChip-CO₂ (**Figure 11**), an integrated MEMS chip (Micro Electro-Mechanical System). This sensor measures 0.45 cm square, has a response time of less than one second, uses only 70 mW and detects CO₂ from 0 to 100% with a resolution of better than ±50 ppm [6].

Detection of gasses is a subject on its own with many specialisations. In this article we showed a few of the common techniques. As a matter of course this also involves a lot of pneumatics and mechanics. We hope you have enjoyed this overview crossing the borders off the purely electronics domain.

(100535-I)

Sources and Internet links

1. www.gs-yuasa.com/gwid/us/products/ke_series/index.html
2. www.aii1.com/Rep_O2_sensors.htm
3. www.teledyne-ai.com/industrialsensors.asp
4. <http://photonics.icxt.com/index.php?page=pulsir>
5. www.shinyei.co.jp/STC/optical/dust_e.html
6. <http://photonics.icxt.com/uploads/files/Datasheets/SensorChipCO2-ds.pdf>
7. www.zyaura.com/products/ZG%20module.asp
8. www.intlsensor.com/pdf/infrared.pdf
9. <http://intlsensor.com/pdf/electrochemical.pdf>

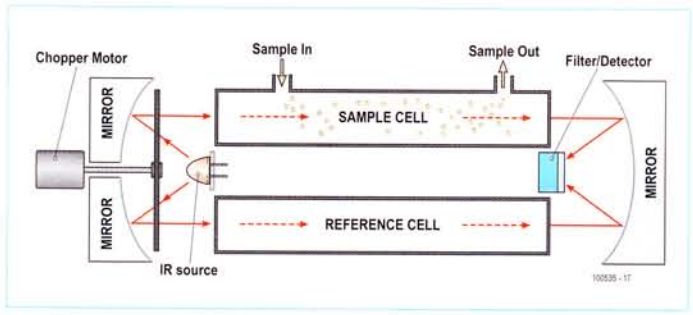

Figure 8. Infrared analyser with chopper motor, reference cell and concave mirrors (source: [8])

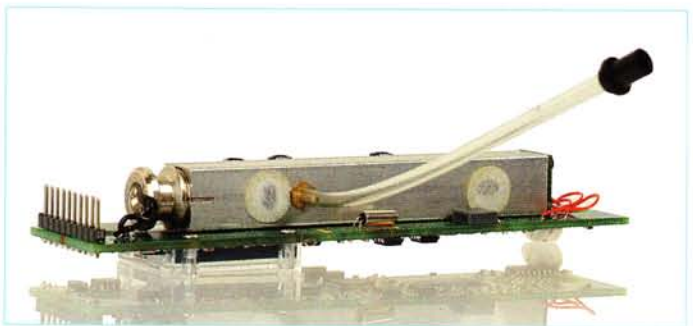

Figure 9. The ZG-02 IR-module from ZyAura (photo: ZyAura)

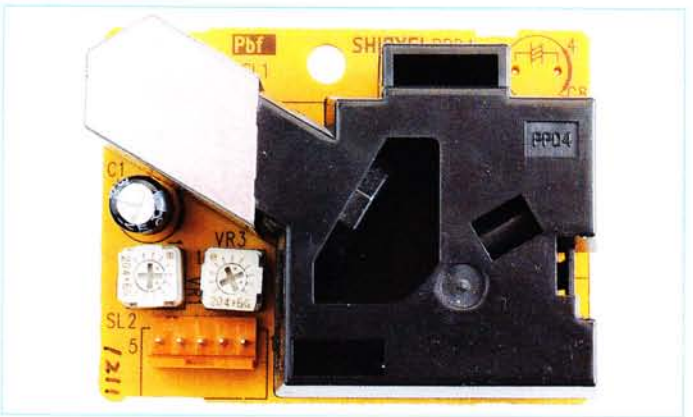

Figure 10. This detector from Shinyei uses IR light for the detection of dust particles and pollen.



Figure 11. The SensorChip-CO₂ is a MEMS chip for measuring CO₂ (photo: ICX Technologies).

Micro Fuel Cell Measures Oxygen Concentration

By Helge Weber (Germany)



Oxygen makes up about 21 % of the air in the atmosphere.

Normally we take this for granted but for some, oxygen concentration can be a matter of life and death. For a diver it is essential to know the oxygen concentration in the breathing gas in his cylinder, and a cave explorer needs to know the oxygen

level in the ambient air he is breathing. This article

describes an oxygen concentration sensor and how to process its output.

We have previously described carbon dioxide sensors based on chemical [1] and optical [2] principles in *Elektor*, and an oxygen sensor complements these designs nicely. The meter described here is based around a Minimod18 microcontroller board [3] featuring an ATmega328 microcontroller and a two-line backlit LCD panel.

Background

Hypoxia (inadequate oxygen supply to the body) can lead to life-threatening situations, in particular for divers and cavers. Symptoms range from a general reduction of awareness through uncontrolled movements to complete loss of consciousness. In such cases medical treatment involves providing emergency respiration, ideally with 100 % oxygen.

Oxygen concentration meters are useful in recreational diving. On many dives these days a breathing gas is used with a higher

concentration of oxygen than that found in atmospheric air. These 'nitrox' [4] mixtures usually have an oxygen level of between 22 % and 40 %. A further application is in so-called 'rebreathers' used by divers.

It is vital for divers to know the concentration of oxygen in the gas they are to breathe. If the concentration is more than 1 % away from the correct value the gas should not be used: the discrepancy must be checked and the dive planned afresh.

The oxygen meter described here will give a sufficiently accurate indication of the oxygen concentration of the gas in scuba breathing equipment.

A second use for the oxygen concentration meter is in caving, for example to monitor the oxygen concentration in the air in a cave. European standard EN50104 for 'Electrical apparatus for the detection and measurement of oxygen' applies in this case. Oxygen meters used for professional

purposes must behave according to the specifications in this standard and be tested against it. Hazards when caving include dangerously high levels of gases such as CO, CO₂, CH₄ and H₂S as well as reduced levels of oxygen. The oxygen meter can thus be a useful addition to gas detector tubes and other monitoring devices.

Principle of operation

Oxygen can be detected relatively straightforwardly using an electrochemical sensor [5][6], also known as a micro fuel cell. The method was first used (and patented) in 1964 for medical applications by the American company Teledyne Analytical Instruments as a sensor in artificial respiration systems.

The internals of the sensor (**Figure 1**) are based around a Teflon membrane with a gold cathode and a lead anode. Oxygen gas molecules diffuse through the Teflon membrane and are electrochemically reduced

Portable oxygen meter using the Minimod18

at the gold cathode. The electrons for this reduction are provided by oxidation of the lead cathode, resulting in a flow of anions and cations between the electrodes. This ion flow corresponds to a current which will increase in magnitude as more oxygen molecules diffuse. The current flow is turned into a voltage using a resistor, and the output of the sensor is in the region of a few millivolts. The transfer characteristics of the sensor change with age (Figure 2).

In normal atmospheric air the output voltage of the sensor lies somewhere between 7 mV and 13 mV, rising linearly with increased oxygen concentration. The lifetime of a micro fuel cell sensor of this type varies from manufacturer to manufacturer and depending on the environment in which it is used, and is typically two or three years.

The meter circuit

The first task is to convert the output of the sensor into a level suitable for input to the A/D converter in the microcontroller. Alternatively, if the sensor is to be used without the microcontroller circuit, the output of the front-end can be connected directly to a millivoltmeter capable of displaying voltages from 0 mV to 199.9 mV. The conversion is done using an operational amplifier

connected in a non-inverting configuration. Figure 3 shows the complete circuit of the front-end stage built around an OP90 [7], with the output taken to the A/D converter input of the microcontroller or to the millivoltmeter as appropriate.

The gain A of the amplifier is set by feedback resistors $R1$ and $R2$ and is given by the formula $A=1+(R2/R1)$. The values given in the circuit diagram result in a gain of 16. Offset compensation of the opamp in Figure 3 is done by $R3$ and $R4$. If the output of the opamp is being used to drive a millivoltmeter for display purposes it is worth connecting a trimmer to pins 1 and 5 and adjusting it to cancel the offset voltage of the opamp. Furthermore, a second trimmer potentiometer can be added in series with resistor $R2$, to allow the output voltage to be set to exactly 20.9 mV in atmospheric air so that the concentration can be read directly from the meter's display.

Construction

The Minimod18 is at the heart of the meter unit. The module includes everything needed for rapid and trouble-free system



Bild 1. Sensor with adapter for connecting to a diver's breathing kit.

construction and integration. The oxygen sensor itself is built into the enclosure (see Figure 5).

The front-end circuit of Figure 4 can be assembled on a piece of prototyping board. All the required connections are to K1 on the Minimod18 board:

pin 1	AREF	reference voltage connection
pin 2	+5 V	power supply
pin 3	ADC6	sensor signal
pin 9	GND	power supply

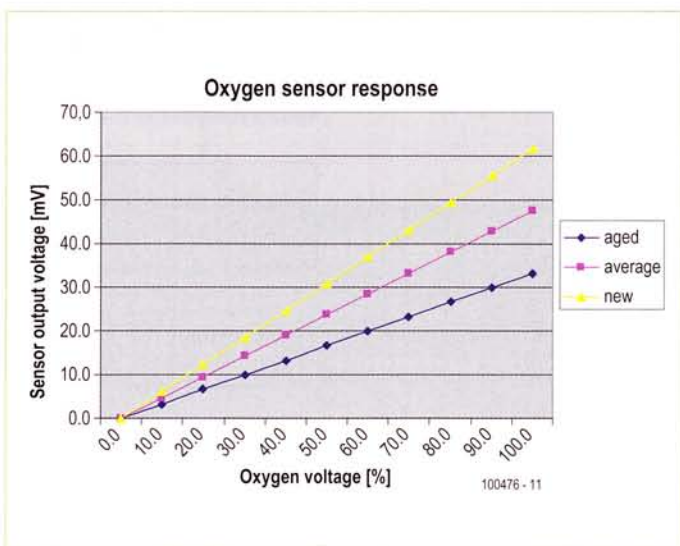

Figure 2. Typical characteristic curve of an oxygen sensor.

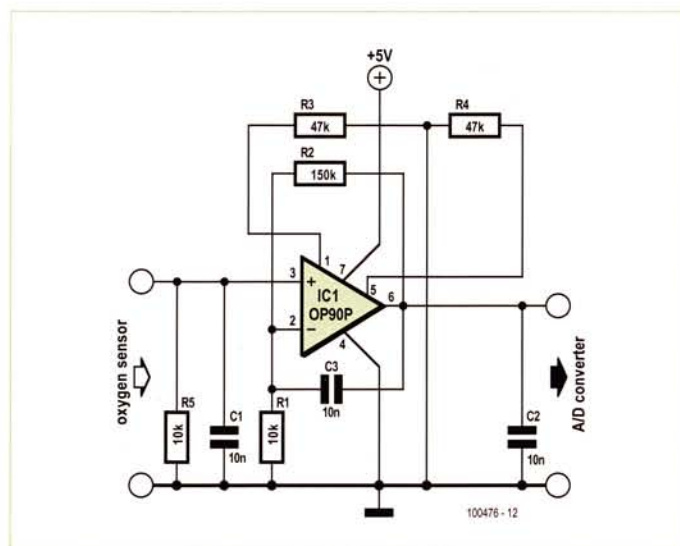

Figure 3. Front-end amplifier circuit to interface the oxygen sensor to an A/D converter.

TEST & MEASUREMENT

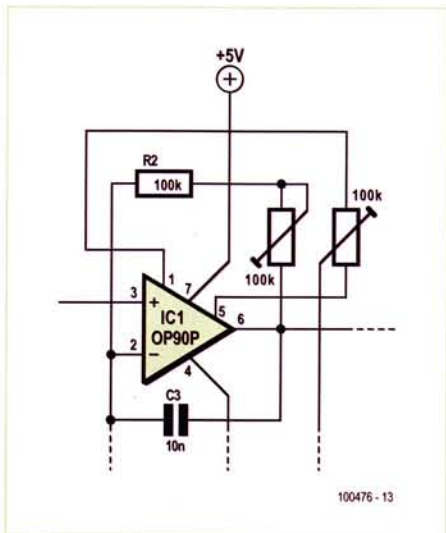

Figure 4. If a millivoltmeter is to be used as a display readout, two calibration potentiometers should be added to the amplifier circuit.

A suitable voltage reference is the LM336-2.5V from National Semiconductor [8]. The amplified sensor signal must of course be calibrated against the reference voltage. The other pins can be used for further expansion. For example, pin 4 (ADC7) could be used to connect another sensor; other inputs could be used to add buttons and so on.

Software

Software for the Minimod18 can easily be written using, for example, BASCOM AVR or CodeVisionAVR. In this case, the author developed software for the prototype

using BASCOM. **Figure 6** gives an overview of the program as a flowchart; source and hex files for the project are available for download from the *Elektor* web pages for this article [9]. Two versions of the code are available: the first is intended for use as a breathing gas (nitrox) analyser; the second is designed for monitoring ambient oxygen levels in air.

The unit can be calibrated using either a one-point method or a two-point method. In the one-point method we assume that the sensor plus front-end circuit have a linear characteristic that passes through the



Figure 5. View of the prototype.

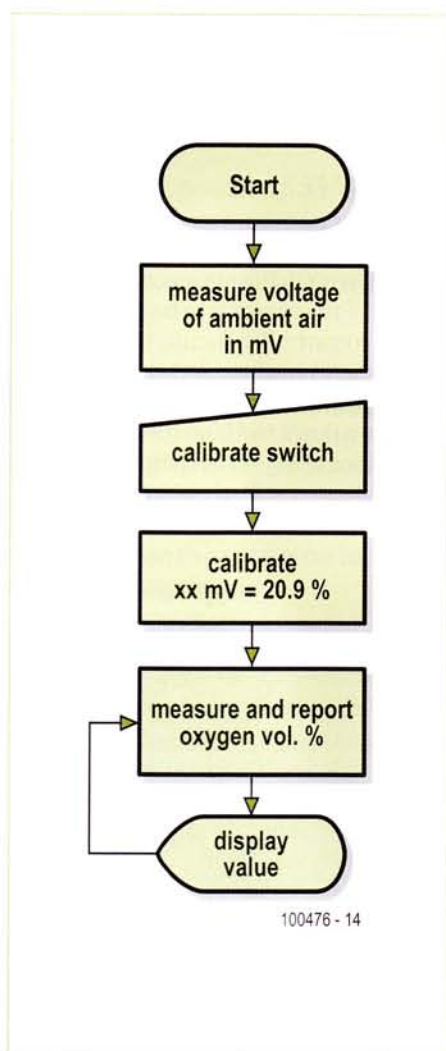

Figure 6. The flowchart illustrates the simple structure of the program.

origin, and so we only need to calibrate the meter to one other point, for example the 20.9 % concentration of oxygen in ordinary atmospheric air.

However, the circuit might exhibit an overall offset, with the straight-line transfer function not passing exactly through the origin. In such cases a two-point calibration gives better accuracy. A reference gas sample, ideally pure oxygen, is needed. The first calibration point is the reading in atmospheric air (concentration 20.9 %, as stated above), and the second point is the reading in the reference gas, with known oxygen concentration. It should be noted that even this process is not perfectly accurate, as the oxygen concentration in atmospheric air is not exactly 20.9 % since the partial pressure of oxygen varies with barometric pressure, humidity and temperature. Inaccuracy due to these effects can however be neglected in the two applications we are considering here.

The unit in practice

A suitable gas sampling device is needed to use the unit to measure the oxygen content of breathing gases. One option is the 'Quick Ox' [10].

When using the unit to monitor ambient air it is a good idea to add warning indicators using LEDs and a buzzer. The author fitted three LEDs to his prototype. A green LED lights when the ambient oxygen concentra-

About the author

Helge Weber is a power electronics engineer and works as a site manager specialising in metallurgy. In his free time he is a rescue diver and diving teacher with the German Life Saving Association.

tion is close to the normal level of 20.9 %. If the concentration falls below 19 % a red LED lights, and if the concentration further falls to below 17 % the buzzer also sounds. A blue LED lights to indicate a concentration of above 22 %, which is useful when checking for leaks when refilling or mixing with oxygen.

The source code can be freely modified to implement further functions. As we have

seen, the hardware required to make an oxygen meter is minimal: just the sensor, an opamp and either a millivoltmeter, or for more sophisticated applications, the Mini-mod18 and a voltage reference.

(100476)

References and links

- [1] Elektor January 2008: <http://www.elektor.com/070802>
- [2] Elektor May 2010: <http://www.elektor.com/100020>
- [3] Elektor January 2010: <http://www.elektor.com/090773>
- [4] <http://en.wikipedia.org/wiki/Nitrox>
- [5] www.teledyne-ai.com/oem/diving.asp (Teledyne oxygen sensors)
- [6] www.aii1.com/Rep_O2_sensors.htm (Analytic Industries oxygen sensors)
- [7] www.analog.com/static/imported-files/data_sheets/OP90.pdf (opamp datasheet)
- [8] www.national.com/ds/LM/LM136-2.5.pdf (voltage reference datasheet)
- [9] www.elektor.com/100476 (pages for this article, including downloads)
- [10] www.vandagraph.co.uk/?page=category&cat=294&subcat=296 (Quick Ox gas sampling adaptor)

Advertisement

Prototype & small series PCB specialists



PCB proto	dedicated prototype service
STANDARD pool	widest choice 1 - 8 layers
New TECH pool	100 µm technology
New IMS pool	metal-backed PCBs
On demand	all options up to 16 layers

Call us: 020 8816 7005 Email: euro@eurocircuits.com
New website – new services

ALL SERVICES

- Instant online pricing
- Instant online ordering
- Low pooling prices
- Deliveries from 2 days
- No tooling charges
- Stencil service

www.eurocircuits.com

The 5532 OpAmplifier (2)

Part 2: construction, bridged operation and test results

By Douglas Self (UK) and Ton Giesberts (Elektor Labs)

In this second and closing instalment we get real with two times 32 NE5532 opamps paralleled to form a high-end audio power amplifier with eminent specifications in terms of distortion and general sonic performance. There are also challenges for you: bridged operation for higher output power, and modifying the amplifier for 4-ohm operation.

If you thought that paralleling a few dozen NE5532 opamps is a curious way of designing a high-end audio amplifier and typical of Elektor's off-the-beaten track approach to electronics you are probably right. Last month's design considerations did not fail to trigger responses from you, our readership, in particular from all and sundry aspiring or even claiming to be a high-end audio designer. This month we get real by building the 5532 OpAmplifier project and putting it through its paces.

Construction — amp board

The amplifier proper is built on a double-sided through plated circuit board of which the component overlay is shown in **Figure 1**. Two of these boards are required for a stereo amplifier. Boards supplied by Elektor come with through plating, a solder mask and holes predrilled. As such they are the best guarantee for success in replicating the project. While on the subject of quality, you are looking at an expensive, high-end amplifier. If you use mishmash components and *ditto* assembly methods and tools, you'll get mishmash results. More on selecting the best NE5532 brand to use in the **inset**.

Construction on the 205 × 84 mm board should not present problems as only standard through-hole parts are used. A properly functioning amp can be expected if you work with care and precision, like Ton Giesberts of Elektor Audio Labs who designed, built and tested all the boards pictured. Some notes and *caveats* deserve mentioning, however.

Most resistors are mounted vertically. Use a uniform method of bending the long terminal twice to obtain right angles. Semicircles indicate where the resistors sit on the board. Where rectangles are printed, the resistor is mounted flat on the board. Although it's possible to solder all opamps directly on the board, you do so at a risk (see part 1), hence the prototype was built using turned-pin 8-way DIL sockets for all opamps. It is essential to use premium quality sockets here — don't be tempted to use cheap ones with dodgy spring contacts; it is false economy.

The tallest components on the board are capacitors C2, coil L1, relay RE1 and the screw terminal blocks for the loudspeaker and supply connections. The coil consists of 10 turns of 1 mm diameter (AWG18) enamelled copper wire (ECW) with an internal diameter of 20 mm. The coil windings should be spread evenly to obtain an overall length to suit the footprint on the board. Fit the coil first, then R106 at a height of 5-10 mm above the board surface and not touching L1 anywhere.

Although printed on the silk screen PCB overlay, **capacitors C24, C25, C26 and C27 are not fitted**. Instead, a single 1,000 µF, 63 V electrolytic capacitor is used, its terminals being inserted directly into terminal blocks K16/K17 (observe the polarity and provide the leads with sleeving for insulation). This should be a high quality electrolytic capacitor with low ESR. The modification proved necessary to get rid of unex-

pected distortion levels occurring at about 20 kHz in the initial design and was found to totally cure the problem. The amplifier specifications printed last month apply to the capacitor-modified version only. The four corners of the amplifier board have holes for PCB standoffs — we used 10 mm tall ones.

The finished amplifier board should be given a thorough visual inspection before taking into use. Did you get all the polarised components' orientations right? Are all solder joints beyond reproach? It often helps to have a friend look at the board. **Figure 1** once again shows the amp board for your reference. See how close you can get to this level of sophistication in building high-end audio circuitry.

Construction — PSU board

This is also a classic board with nothing but standard components, hence should be easy to assemble and get working. It's just the heatsinking of the voltage regulators that requires some mechanical work. The two bridge rectifiers B1 and B2 should be fitted with 2 mm thick 70 x 35 mm aluminium plates bolted directly to the flat sides. The two voltage regulators IC1 and IC2 are secured to a single black, finned, extruded aluminium heatsink of which the mounting outline is shown on the component overlay. The heatsink is secured to the board with three M4 screws or bolts, for which holes need to be drilled and tapped in the underside. Venting holes are provided in the PCB area under the heatsink

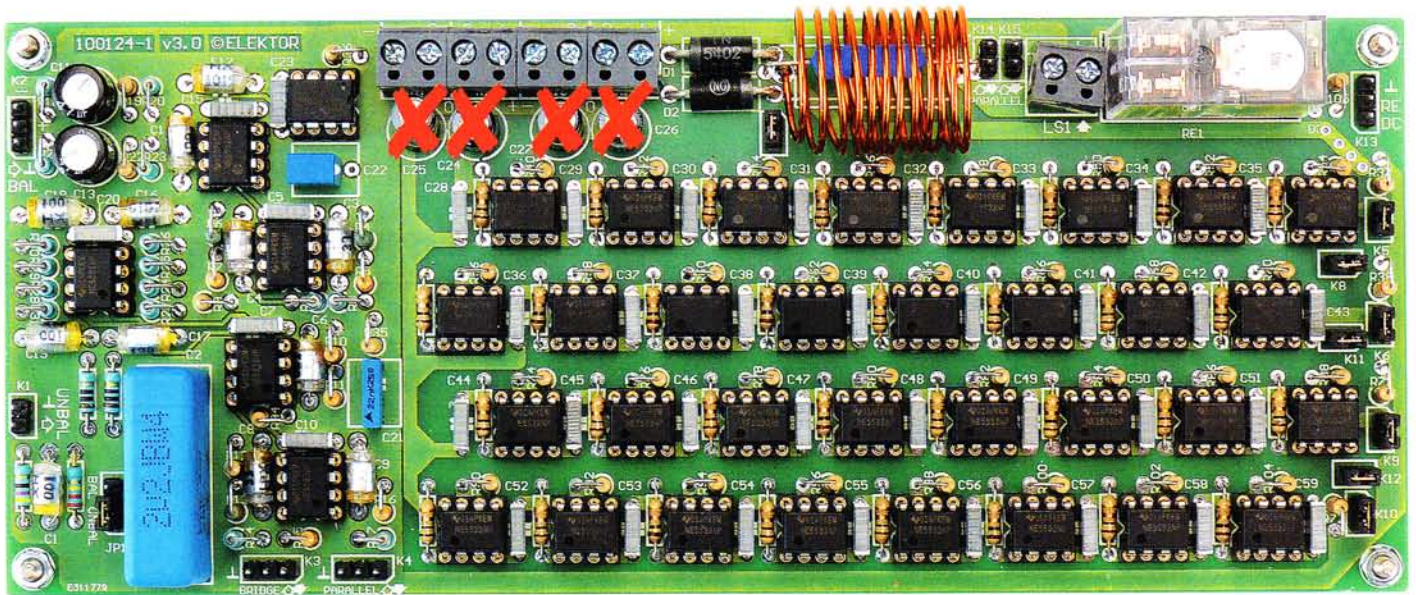

Figure 1. Perfect sound from perfect construction. Can you match it? Please note that capacitor positions C24–C27 must remain empty.

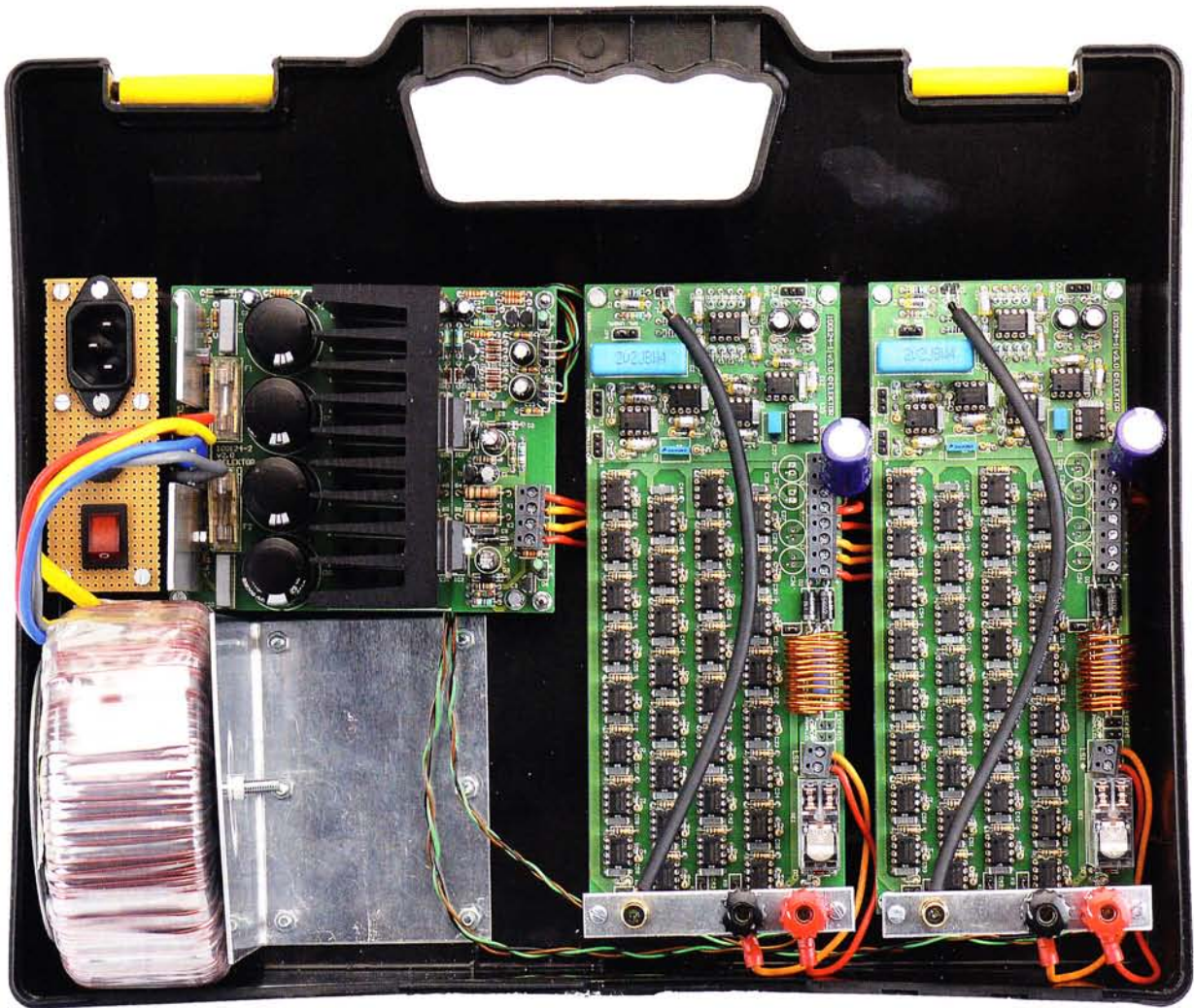

Figure 2. The power supply board is conventional as far as construction and assembly is concerned, but do make sure you get the mounting of the heatsink and the voltage regulators right. An ABS suitcase as shown here is not recommended as a permanent housing for the amplifier.

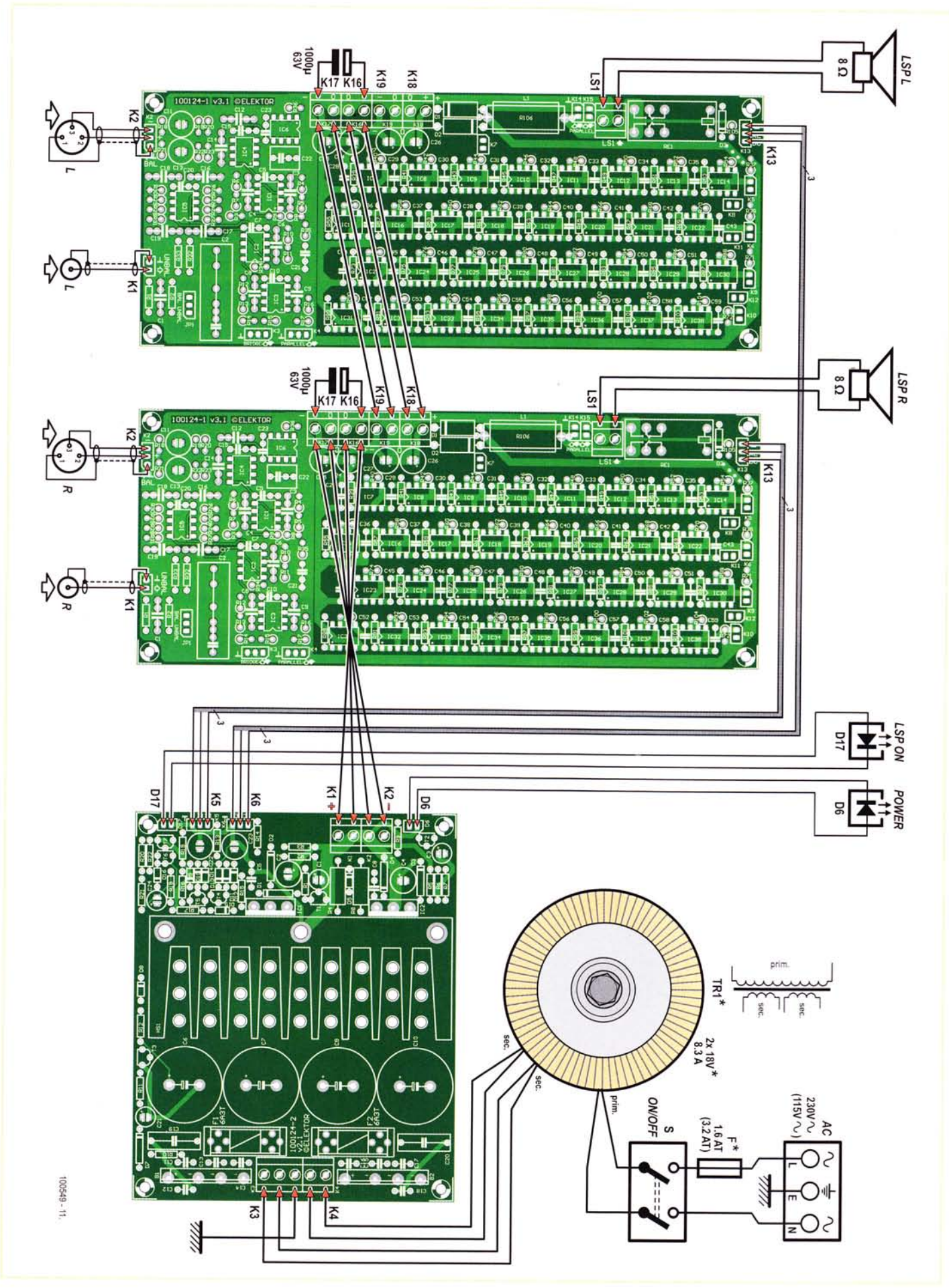

Figure 3. OpAmp interwiring diagram. Note that this is for the 2 x 15 watts, 8-ohm version. The electrical ratings of the toroidal transformer and the fuse should match your local AC line voltage. High amps and loudspeaker connections are shown in slightly thicker lines.

Masterclass #1: Extension of design for 4 ohm speakers

It is an inherent property of the 5532 power amplifier that its output current is limited by the internal overload protection of the opamps used. This means that if more current is needed in the load, you need to put more opamps in parallel. The basic design is intended to drive 8 Ohm loudspeakers with a reasonable safety margin, but as it stands it is definitely not recommended for 4 ohm operation.

To extend the 5532 amplifier for 4 ohm operation, it is necessary to double the number of 5532 sections driving the output. This is easier than it might sound because facilities are provided for adding one or more power amplifier PCBs in parallel. The connector K4 (see circuit schematic published last month) is used as an output from the main power amplifier PCB; it comes from the 'zero-impedance' stage IC3A, so the output is at a very low impedance (I measured 0.24 ohms at 1 kHz) but is immune to HF instability caused by cable capacitance. Any desired length of cable can be used. The output from K4 drives an identical power amplifier PCB that has the all the output opamps in place, but the redundant input amplifier circuitry

omitted. The equivalent connector K4 on this PCB is used as an input, and drives the output opamps in exactly the same way as on the main power amplifier PCB.

The connectors K14, K15 are used to connect together the outputs of the two amplifier PCBs. Note that this connection is made upstream of the output muting relay RE1, to preserve full protection for the loudspeaker in case of a DC fault.

While this conversion for 4 ohm operation is relatively straightforward, it is essential to remember that the power supply requirements are doubled along with the current output. You will need to consider a larger power transformer, more capable rectifiers, larger reservoir capacitors, and increased supply regulator capacity. In view of these various requirements, this 4 ohm version is mentioned here more as an option for the experimenter rather than a fully cut-and-dried design.

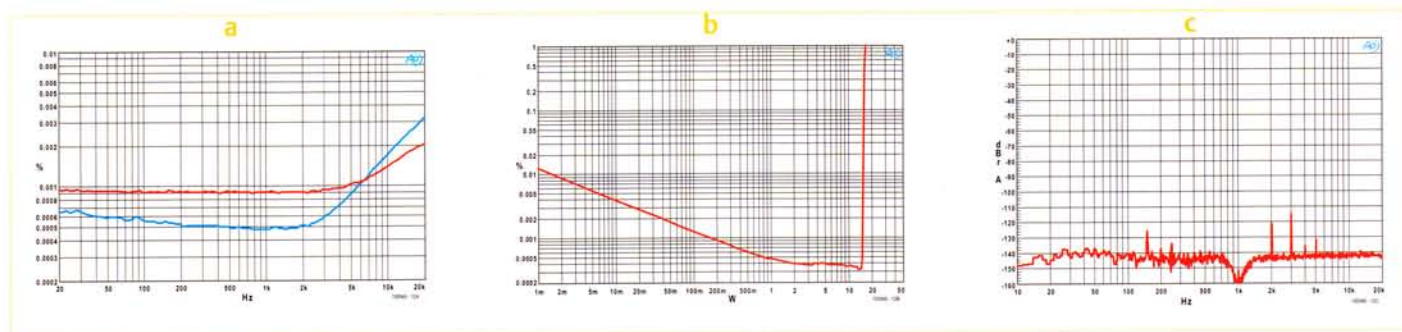

Figure 4. The OpAmplifier was duly 'grilled' on our AP System 2 analyser.
Graph (a): THD & noise vs. output power. Graph (b): distortion vs. output power (1 kHz, BW = 22 KHz).
Graph (c): FFT graph for 1 kHz, 1 watt, 8 ohms.

to assist cooling. The LT1083CP devices are secured to the heatsink with a heat conducting washer inserted. Two holes have to be drilled for the M3 bolts and nuts that hold the regulators firmly on the heatsink. First, determine the location of the holes for the regulators; then secure the heatsink to the board. The regulator terminals should be 'kinked outward' slightly for thermal relief. The two LT1083 regulators should be mounted, secured and soldered last.

Figure 2 shows the PSU board in a "travel & demo" version of the amplifier. PCB stand-

offs are used as with the amplifier board. The PSU can be tested (carefully) by temporarily connecting the secondaries of the toroidal transformer to the AC input terminals and checking for the correct output voltage of $18.0 \text{ VDC} \pm 0.7 \text{ V}$ on each rail.

The complete amplifier

The OpAmplifier should be built into in a metal case observing all relevant precautions in respect of electrical safety, specifically with respect to earthing and the use of wiring carrying the AC grid voltage (230 V or 115 V). The size and shape of the

case will depend on the number of amplifier boards used, as well as the associated power supply, see the **insets on bridged operation and 4-ohm conversion**. Allow for quite some heat developing in the amplifier case, from the heatsink as well as from the NE5532s. All those milliwatts add up!

Everything ahead of the bridge rectifier AC terminals should be built, secured and wired with the high currents and voltages always in mind. If possible, do not extend the transformer wires. The amplifier interwiring diagram for the 8 ohm 2 x 15 watts

Masterclass #2: Extension of design for bridged operation

Two power amplifiers are bridged when they are driven with anti-phase signals and the load connected between their outputs; the load is not connected to ground in any way. This method of working doubles the signal voltage across the load, which in theory at least quadruples the output power. It is a convenient and inexpensive way to turn a stereo amplifier into a more powerful mono amplifier. Most conventional power amplifiers do not give anything close to power quadrupling- in reality the increase in available power will be considerably less, due to the power supply sagging and extra voltage losses in the two output stages, which are effectively in series. In most cases you will get something like three times the power rather than four times, and it may be less. I have come across many power amplifiers where the bridged mode only gave twice the output power, and it has to be said that in many cases the bridged mode looks like something of an afterthought.

The 5532 power amplifier will give better results than that for two reasons — firstly the power supply rails are regulated, and will not droop significantly under heavy loading. Secondly, the parallel structure minimises voltage losses; for example, all the 1 ohm output combining resistors are in parallel and their effective resistance is therefore very small.

Bridged mode is so called because if you draw the four output transistors of a conventional amplifier with the load connected between them, as in **Figure A**, it looks something like the four arms of a Wheatstone bridge.

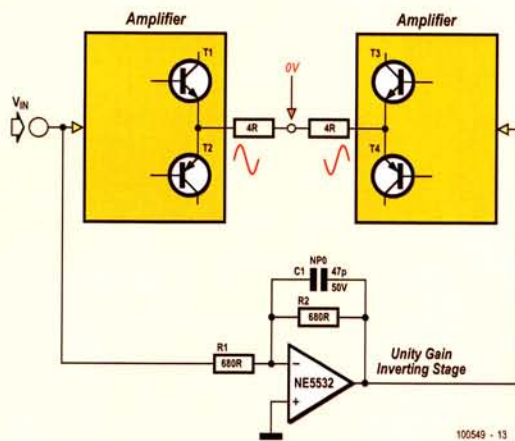

In the drawing, the 8 ohm load has been divided into two 4 ohm halves, to emphasise that the voltage at their centre is zero, and so

as far as current output is concerned, both amplifiers are effectively driving 4 Ohms loads to ground. The current capability required is therefore doubled, with all that that implies for increased losses in the output stages. A unity-gain inverting stage is shown generating the anti-phase signal; there are other ways to do it but this is the most straightforward and it simply adds one more 5532 section to a design that already contains quite a few of them. The simple shunt-feedback unity-gain stage shown does the job very nicely, and the 5532 power amplifier incorporates a version of this circuit. The resistors in the inverting stage need to be kept as low in value as possible to reduce their Johnson noise contribution, but not of course made so low that the opamp distortion is increased by driving them. The capacitor C1 across the feedback resistor R2 assures HF stability — with the circuit values shown it gives a roll-off that is -3 dB at 5 MHz, so it does not in any way imbalance the audio frequency response of the two amplifiers.

You sometimes see the glib statement that bridging always reduces the distortion seen across the load because the push-pull action causes cancellation of the distortion products. It is not true. Push-pull systems can cancel even-order distortion products; odd-order harmonics will not be cancelled.

The 5532 power amplifier has facilities for bridging built in. The last stage in the input amplifier is the inverting stage around IC3A, which is needed to get the phase between amplifier input and output correct. If we take the signal off from before this stage, then it is inverted with respect to the amplifier output and can so be used to drive another power amplifier board in anti-phase; this PCB can be built with the input amplifier circuitry omitted, as for the 4 ohm conversion described above. This inverted signal is available at connector K3. The loudspeaker is connected between the two output terminals on the amplifier PCBs and the output ground terminals are not used.

As explained above, driving an 8 ohm load with two bridged power amplifiers means that each amplifier is effectively driving a 4 ohm load to ground, so to take full advantage of the bridging capability requires the output stages to be doubled up, so that there are two power amplifier PCBs in parallel driving in-phase, and two power amplifier PCBs in parallel driving in anti-phase. This is of course quite a serious undertaking, as the number of output opamps has been doubled for bridging, and then doubled again to give adequate output current capability. The power supply capability will also need to be suitably increased.

stereo version of the amplifier is shown in **Figure 3**. The rating of the AC power fuse should match the line voltage in your area (115 V/60 Hz or 230 V/50 Hz). Whichever, an approved IEC style appliance socket with integral fuseholder and double-pole rocker switch **must be used**.

We should emphasise that the 8.3-amp toroidal transformer indicated in the

drawing is advised for the 2 x 15 watt, 8-ohm version of the OpAmplifier. A much beefier transformer is required if you decide to build a 4-ohm or bridged version of the amplifier. As with nearly all audio power amplifiers, it's essential to have a good deal of spare capacity in the 'amps department' so do not skimp on the transformer.

The test results

The basic concept behind the 5532 power amplifier is to create an amplifier which has the very low distortion of the 5532 opamp. Preserving this performance when large currents are flowing to and fro on a circuit board is something of a challenge and requires very careful attention to grounding topology, supply-rail routing, and

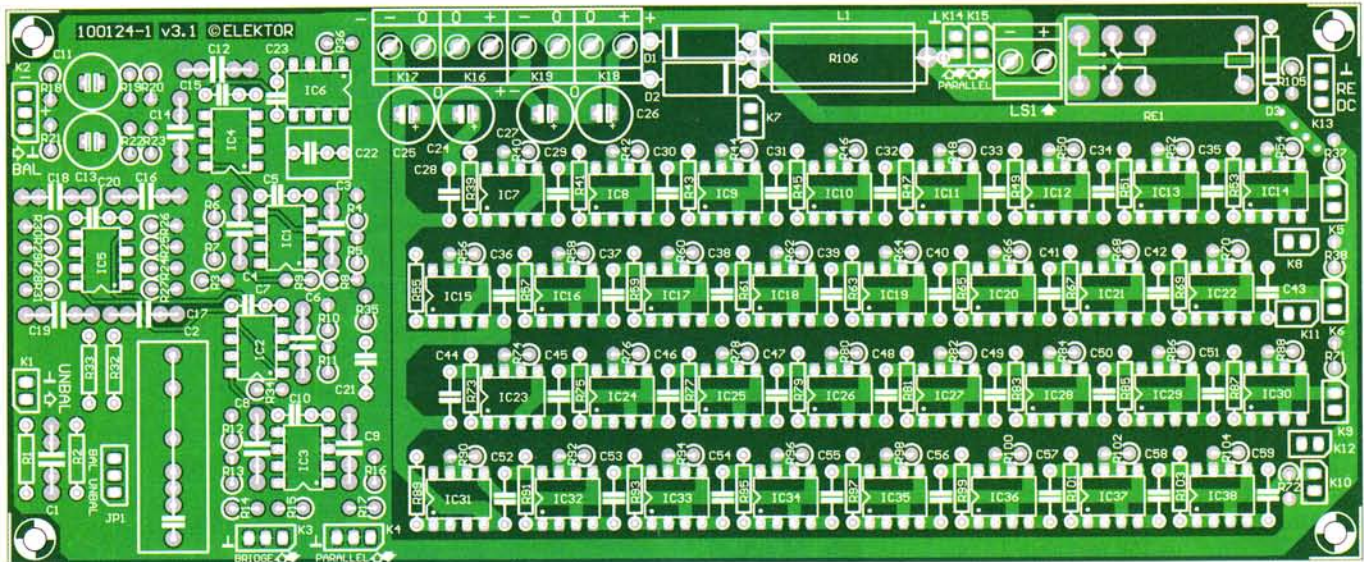

COMPONENT LIST

Amplifier board (one channel)

Resistors

5%, 0.25W, Farnell/Multicomp MCF series, unless otherwise indicated.

R1, R14, R17 = 47 Ω
 R2 = 220k Ω
 R3 = 47k Ω
 R4, R6 = 910 Ω 1% 0.25W, Multicomp type MF25 910R
 R5, R7, R10, R11, R15, R16 = 2.2k Ω
 R8, R9, R32, R33 = 10 Ω
 R12 = 1k Ω
 R13 = 2.00k Ω 1% 0.25W, Multicomp type MF25 2K
 R18, R21 = 150k Ω
 R19, R22 = 100 Ω
 R20, R23 = 68k Ω
 R24-R31 = 820 Ω
 R34, R35 = 10M Ω
 R36 = 100k Ω
 R37, R38, R71, R72 = 22k Ω

R39-R70, R73-R104 = 1 Ω

R105 = 10k Ω

R106 = 10 Ω 5% 3W, Tyco Electronics type ROX35J10R

Capacitors

C1, C12, C14, C16-C19 = 100pF, 2.5%, 160V, polystyrene, axial (LCR Components)
 C2 = 2.2 μ F 5% 250V, polypropylene, Evox Rifa type PHE426HF7220JR06L2
 C3, C4, C6, C8, C9 = 33pF \pm 1pF 160V, axial, polystyrene (LCR Components)
 C5, C7, C10, C15, C20, C23, C28-C59 = 100nF 10% 100V, lead pitch 7.5mm, Epcos type B32560J1104K
 C11, C13 = 47 μ F 20% 35V non polarised, Multicomp type NP35V476M8X11.5 (Farnell # 1236671)
 C21 = 22nF 10%, 400V, lead pitch 7.5mm, Epcos type B32560J6223K (Farnell # 9752366)
 C22 = 1 μ F, 10%, 10V, lead pitch 7.5mm, Epcos type B32560J1105K (Farnell # 9752382)
 C24-C27 = not fitted, see text

Inductors

L1 = 1.7 μ H; 10 turns 1 mm (18AWG) ECW,

diameter 20mm, effective length 20mm

Semiconductors

D1, D2 = 1N5402

D3 = 1N4148

IC1-IC5, IC7-IC38 = NE5532 (see text for notes on device selection)

IC6 = OP177 (Analog Devices)

Miscellaneous

K1, K5-K12, K14, K15 = 2-pin SIL pinheader, lead pitch 0.1 inch

K2, K3, K4, K13 = 3-pin SIL pinheader, lead pitch 0.1 inch

K16-K19, LS1 = 2-way PCB terminal block, lead pitch 5mm

JP1 = 3-pin SIL pinheader and jumper, lead pitch 0.1 inch

RE1 = PCB mount relay, PCB, DPCO, 24VDC/1100 Ω /5A, Omron type G2R-2 24DC

Phono socket, chassis mount, black, Neutrik type NYS367-0

XLR socket, chassis mount, 3-way, Pro Signal type PSG01588

PCB # 100124-1, Elektor Shop, see www.elektor.com/100549

decoupling arrangements. For this reason it is strongly recommended that you use the Elektor PCB design — better still, ready-made boards supplied by Elektor.

The completed prototype was measured using Elektor Labs' **Audio Precision System Two Cascade Plus 2722 Dual Domain** test-set, and **Figures 4a, 4b and 4c** show

the pleasing and impressive results. **Figure 4a** shows the harmonic distortion and noise as a function of signal frequency. Measurements carried out at 1 watt (red) and 8 watts (blue) of output power within 80 kHz bandwidth. The graph in **Figure 4b** shows distortion as a function of output power at 1 kHz and a bandwidth of 22 kHz. From about 3 watts the amplifier actu-

ally gets close to the lower measurement threshold and noise floor of our analyser! At 15 watts (roughly) the amplifier veers off into clipping. The curve in **Figure 4c**, finally, is an FFT plot for 1 kHz, 1 watt into 8 ohms. The fundamental frequency is suppressed. The second harmonic is way down at -121 dB and the third harmonic slightly higher at -115 dB. At a bandwidth

COMPONENT LIST

Power supply board

Resistors

5%, 0.25W, Farnell/Multicomp MCF series, unless otherwise indicated.

- R1,R5 = 100Ω
- R2,R6 = 1.30kΩ 1% 0.25W, Multicomp MF25 1K3
- R3,R7 = 39Ω
- R4,R8 = 1.5kΩ 5% 1W, Multicomp MCF 1W 1K5
- R9,R11,R16,R20-R22 = 2.2kΩ
- R10,R12-R15,R19 = 47kΩ
- R17 = 150kΩ
- R18 = 470kΩ

Capacitors

- C1,C3,C24 = 47μF 20% 25V, lead pitch 2.5mm, Rubycon type 25ZLG47M6.3X7
- C2,C4 = 100μF 20% 25V, lead pitch 2.5mm, 1.43A AC, Nichicon type UPM1E101MED
- C5,C8 = 100nF 10% 100V, lead pitch 7.5mm, Epcos type B32560J1104K
- C6,C7,C9,C10 = 4700μF 20% 35V, lead pitch 10mm, snap in, Panasonic type ECOS1VP-472BA (25mm max. diameter)
- C11-C18 = 47nF 10% 50V ceramic, lead pitch 5mm
- C19,C20 = 47nF 20%, 630VDC X2, lead pitch 15mm, Vishay BCcomponents BFC233620473
- C21 = 4.7μF 20% 63V, lead pitch 2.5mm
- C22,C23 = 22μF 20% 35V, non polarised, lead pitch 2.5mm, Multicomp NP35V226M6.3X11

Semiconductors

- D1-D4,D7 = 1N4002
- D5,D8-D16 = 1N4148
- D6,D17 = LED, green, 3mm

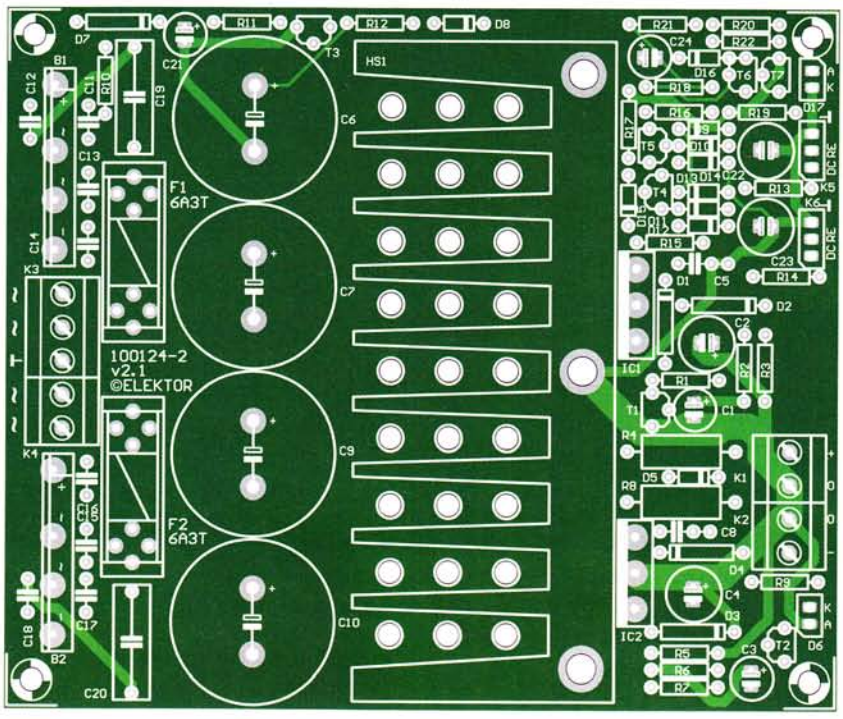

- T1,T3,T4,T6 = BC337
- T2,T5,T7 = BC327
- IC1,IC2 = LT1083 (Linear Technology)
- B1,B2 = GSIB1520 (15A/200V bridge rectifier) (Vishay General Semiconductor)

Miscellaneous

- K1,K2,K4 = 2-way PCB terminal block, lead pitch 5mm
- K3 = 3-way PCB terminal block, lead pitch 5mm
- D6,D17,S1 = 2-pin SIL pinheader, lead pitch 0.1 inch
- K5,K6 = 3-pin SIL pinheader, lead pitch 0.1 inch

- F1,F2 = fuse, 6.3A antisurge (time lag), with 20x5mm PCB mount fuseholder and cover Heatsink, Fischer Elektronik type SK92/75SA 1.6 K/W, size: 100x40mm, Farnell # 4621578, Reichelt # V7331G

Miscellaneous, mechanical

- M3 screws, nuts and washers for mounting IC1 and IC2 to heatsink (see text)
- TO-3P thermal pad, (Bergquist type K6-104)
- M4x10 screws for mounting heatsink to PCB PCB # 100124-2, Elektor Shop, see www.elektor.com/100549

of 22 kHz, the total level of noise and harmonics is about 0.0005%. If the distortion is measured for the two strongest harmonics only, it is at a level of 0.0002%.

Conclusion

To the non-initiated, the OpAmplifier with its case closed may be just another high-end audio amplifier albeit with quite impressive specs relative to the investment. To the discerning electronic engineer, it's a delightful and off-the beaten path approach to getting high-quality audio watts from a dead common component like the NE5532 you

normally associate with nano-ampères and microvolts electronics-wise, and pennies in the financial department!

The proof of the pudding is in the eating. That's why a demo version of the OpAmplifier was cased up in a rugged suitcase for easy transporting, packaging and demoing. At the time of writing, it's about to leave Elektor House on a journey along several audiophiles and audio communities around the world for listening tests. Their feedback is awaited eagerly.

(100549)

Spoil for choice — which 5532?

It is an unsettling fact that not all 5532 opamps are created equal. The design is made by a number of manufacturers, and there are definite performance differences. While the noise characteristics appear to show little variation in my experience, the distortion performance does appear to vary significantly from one manufacturer to another. Although, to the best of my knowledge, all versions of the 5532 have the same internal circuitry, they are not necessarily made from the same masks, and even if they were, there would inevitably be process variations between manufacturers

Since the distortion performance of the amplifier is unusually, and possibly uniquely, dependent on only one type of semiconductor, it makes sense to use the best parts you can get. In the course of the development of this project 5532s from several sources were tested. I took as wide a range of samples as I could, ranging from brand-new devices to parts over twenty years old, and it was reassuring to find that without exception, every part tested gave the good linearity we expect from a 5532. The information here will be of use not only in the 5532 power amplifier project, but should prove very valuable for anyone using 5532s in high-quality applications.

The main sources at present are Texas Instruments, Fairchild Semiconductor, ON Semiconductor, (was Motorola) NJR, (New Japan Radio) and JRC (Japan Radio Company). TI, ON Semi and Fairchild samples were compared in the Elektor labs by Ton Giesberts. The author for his part did THD tests on six samples from Fairchild, JRC, and Texas, plus one old Signetics 5532 for historical interest. The Elektor lab tests were carried out on an actual and very crucial section of the OpAmp design: the driver section! See **Figure A** for the circuit and **Figure B** for the AP2 plots.

As it turned out, the Texas 5532s (green line) proved to be distinctly inferior, both in the Elektor Labs and in the author's tests. We have to admit this surprised us, as we have always thought that the Texas part was one of the best available, but the measurements say otherwise. Distortion at 20 kHz ranges from 0.001% to 0.002%, showing more variation than Fairchild and ON Semi as well as being higher in general level. The low-frequency section of the plot, below 10 kHz, is approaching the measurement floor, as for all the other devices, and distortion is only just visible in the noise.

Compared with other maker's parts, the THD above 20 kHz is much higher— and at least 3 times greater at 30 kHz. Fortunately this should have no effect unless you have very high levels of ultrasonic signals that could cause intermodulation. If you have, then you have bigger problems on your hands than picking the best opamp manufacturer...

The graphs show undisputedly that the Fairchild 5532s (blue line) are top of the bill and true audio purists should select these devices even if they come at a slightly higher price as well as being awkward in terms of type code print on the device. Check with your supplier, it should be worth your while. There is effectively no distortion visible above the noise floor up to about 12 kHz, and distortion at 20 kHz is less than 0.0005%.

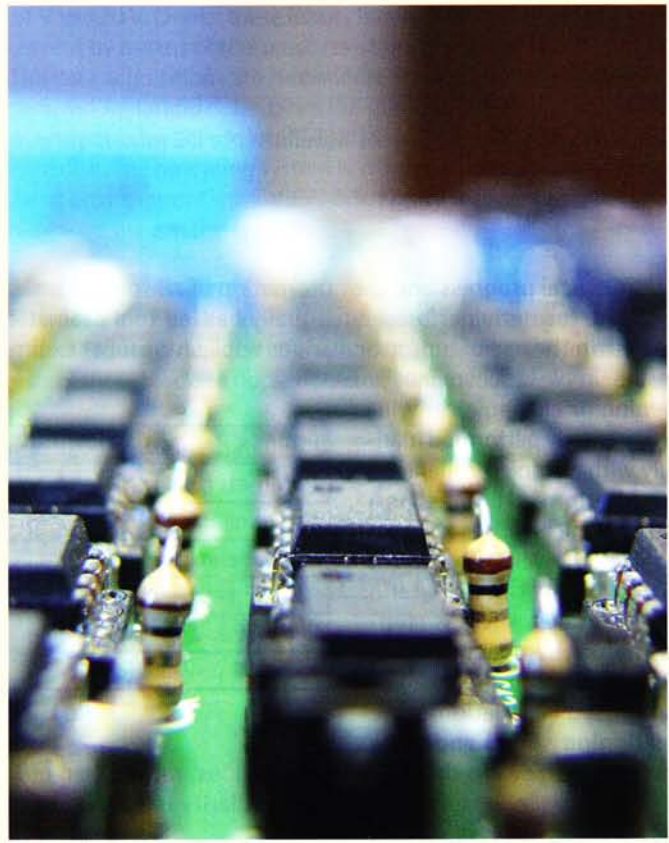
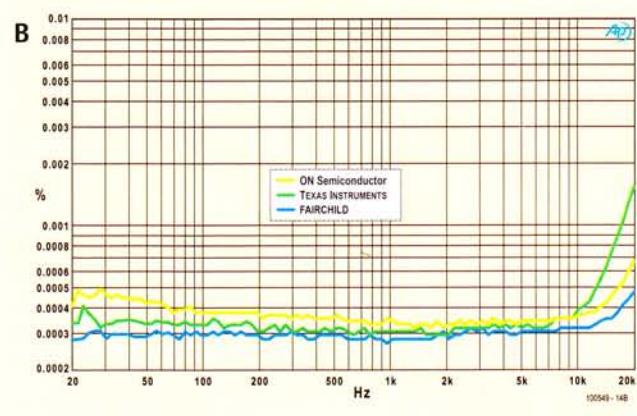
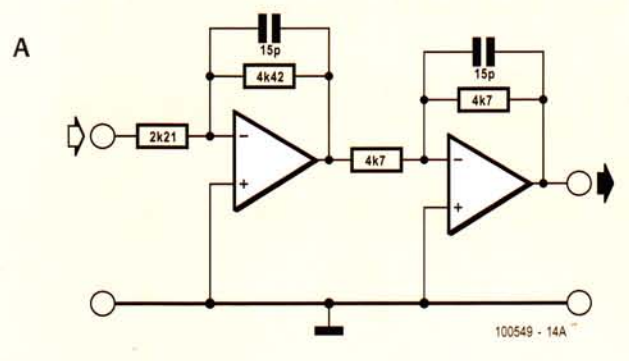

Sensorless Motor Speed Measurement

A new method based on current monitoring

By Ernesto Vázquez Sánchez and Jaime Gómez Gil (Spain)

A characteristic property of DC motors is that they can also act as generators, due to the complementary nature of Faraday's and Lenz's laws of magnetic induction. Thanks to this relationship, it is possible to devise a technique that measures the speed of a DC motor by monitoring the current drawn by the motor. In this article we describe a method of this sort, which can be used in a wide variety of applications.

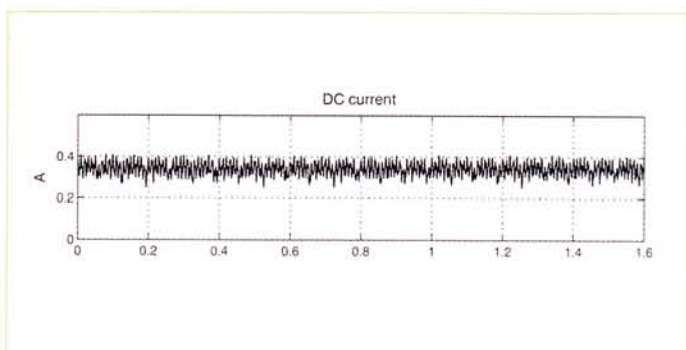

Figure 1. Supply current waveform of a DC motor.

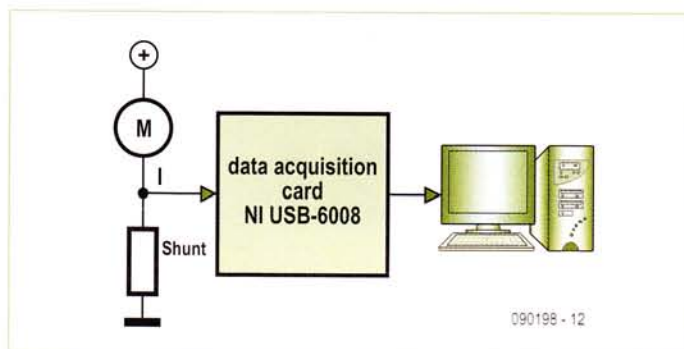

Figure 2. Wiring diagram of the various components.

Technological progress and the automation of all sorts of tasks that were formerly performed manually has led to a dramatic increase in the use of motors in various applications. For example, the simple task of manually opening or closing a car window, formerly performed manually with a crank mechanism, is now performed by pressing a button, which causes a motor to raise or lower the window. DC motors of this sort (and their relatives, such as stepper motors, servo motors and brushless DC motors) are primarily used in situations where positioning speed and positioning accuracy are the main considerations, rather than efficiency or power consumption. Their popularity is partly due to the fact that it is easy to drive a DC motor.

Table 1. DC motor specifications.	
Parameter	EMG30
Rated voltage	12 V
No-load current	530 mA
Rated speed	3000 rpm
Resistance (R_a)	1.8 Ω
Back EMF constant (c)	0.0178 V/rpm

In many applications of DC motors, the motor speed (rpm) must be controlled by a closed-loop system, which means that it is necessary to measure how fast the motor is turning. Transducers and sensors such as tachometers, encoders and Hall-effect devices are commonly used for this purpose. They are fitted on or near the motor shaft, preferably close to the load. These components increase the risk of malfunctions, as well as the overall cost of the system.

As an alternative to sensors and transducers of this sort, here we describe a method for measuring the motor speed that operates solely on the basis of the current drawn by the DC motor. This method is based on the electromotive force (EMF) generated in the motor windings. As you know,

SPEED MEASUREMENT



Figure 3. The system hardware.

the EMF induced in a coil rotating in the magnetic field of a motor has a sinusoidal waveform. This signal is rectified by the commutator on the rotor. After it is rectified, a small ripple voltage remains.

The amplitude of this ripple voltage is proportional to the number of windings in the motor. This ripple voltage is an AC voltage whose frequency is directly proportional to the speed of the DC motor as indicated by equation (1), where f is the frequency of the AC voltage (this is called the ripple frequency), p is the number of pole pairs in the DC motor, k_q is the number of commutator segments on the rotor, n is the speed of the motor in rpm, and η is the greatest common denominator of $2p$ and k .

$$f = \frac{2pk_q n}{60\eta} \quad [1]$$

Figure 1 shows an example of the current measured at the terminals of a DC motor. Here you can see that the current consists of a DC component with a value of approximately 0.3 A and an AC component with a peak-to-peak amplitude of 0.1 A.

System hardware

Figure 2 shows the schematic diagram of our system hardware. It includes a DC motor, in this case a type EMG30, whose specifications are listed in Table 1. The current is sensed by a 20 mΩ sense resistor. The voltage across this resistor is measured by an inexpensive data acquisition card (NI USB-6008), which has a maximum sampling rate of 10 kHz. This card has four differential analogue inputs, which can be configured to have a measuring range from ±1 V to ±20 V. One of these inputs is used here to sample the motor current by means of the sense resistor.

The data acquisition card is connected to a PC, which processes the sampled signal and determines the speed of the DC motor. The PC is a laptop model with an Intel T8300 CPU, 3 GB of RAM and a 320-GB hard disk. The operating system is Windows Vista, and the development environment is LabVIEW 8.5. Figure 3 shows a photo of the hardware used in the system.

Measurement algorithm

Now let's look at the algorithm we used to determine the motor speed. Figure 4 depicts the method in block diagram form. It consists of three blocks: a ripple detector, a frequency meter, and a con-

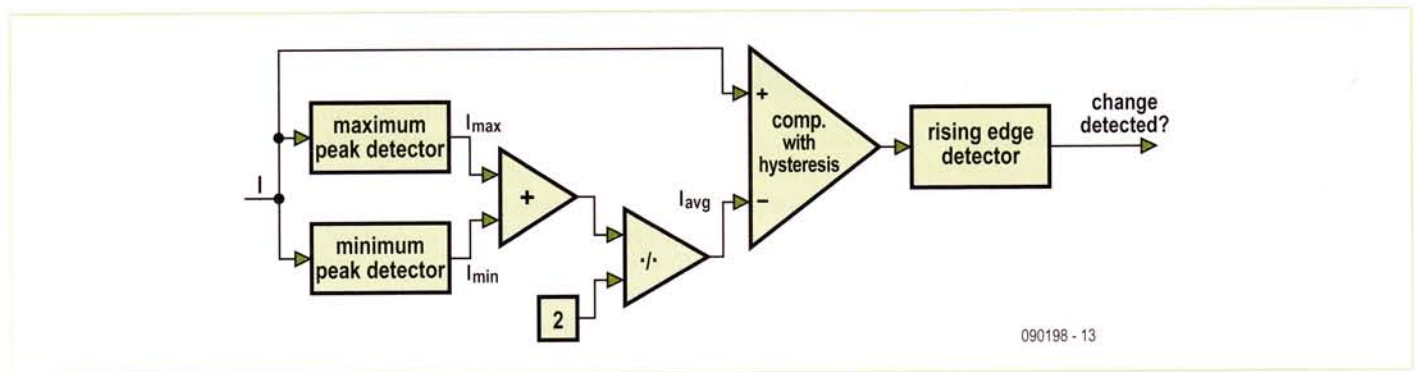

Figure 4. Block diagram of the motor speed detection method.

SPEED MEASUREMENT

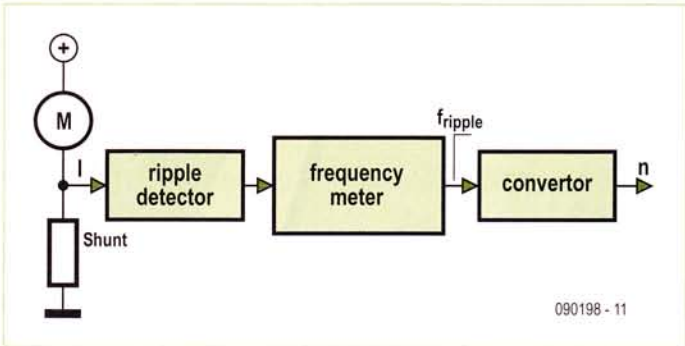

Figure 5. Block diagram of the ripple detector.

verter. The ripple detector ensures that all variations in the motor current waveform are detected. The frequency meter calculates the period of each waveform cycle, thereby determining the frequency of the AC component. Finally, the converter translates this frequency into the speed of the motor.

Ripple detector

This function of this block is to detect the starting point of every waveform cycle of the AC component of the motor current. **Figure 5** shows the block diagram of the ripple detector. The signal from the sense resistor is fed to a maximum peak detector and a minimum peak detector, which determine the minimum and maximum signal levels. The threshold level of the peak detectors is successively reduced at regular intervals. As a result, the detector circuit can

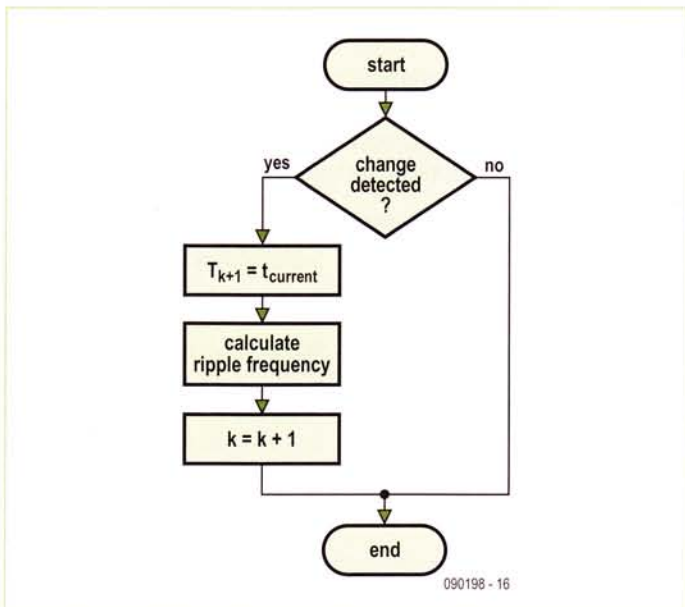

Figure 6. Flow chart of the frequency meter.

adapt quickly and dynamically to the actual minimum and maximum signal levels.

After detection, the average value of the minimum and maximum values (I_{avg}) is calculated. This value is then compared to the total current by a comparator, which operates with hysteresis to suppress the effects of small noise signals. The square-wave output signal from the comparator is fed to an edge detector. The logical output of the edge detector is 'True' if the sampled signal is high and the previously sampled signal was low.

Here we should also mention that the system processes each sample in turn and the processing takes place in real time. This means that when the output of the edge detector is 'True', the crossover point of the signal has already occurred at the time when the signal was sampled.

Frequency meter

This block calculates the motor speed based on the signal crossover times. The flow chart is shown in **Figure 6**. First it checks whether a level change has occurred. If nothing has changed, no action is taken. Otherwise, when a level change has occurred, the time when the change occurred is added to the list of crossover points T_{k+1} , where k is the number of detected crossover times.

After this, the ripple frequency is calculated using an approximation formula (2), where N is the number of crossover points for which the average value must be calculated as indicated in equation (3), f_k is the ripple frequency determined for the most recently detected crossover, f_{k+1} is the ripple frequency currently being calculated, and T_p is the length of time over which the average value is calculated. The operation $[\cdot]$ determines the integer value. This method yields a noise-free motor speed measurement, and it tracks changes in the motor speed well if the value of T_p is chosen properly. Finally, the number of detected crossover points k is incremented by 1.

$$f_{k+1} = \frac{N}{\sum_{i=0}^{N-1} T_{k+1-i} - T_{k-i}} \quad [2]$$

$$N = [T_p f_k] \quad [3]$$

Converter

This block is responsible for deriving the DC motor speed in rpm from the ripple frequency determined by the previous block. Equation (1) is used for this purpose.

Testing and results

To see whether the described method for the determining the motor speed works properly, we performed a variety of tests. First we determined the mean error and the deviation of the error with the motor running at a constant speed. Next we measured the error and the lag with the motor speed changing linearly (constant acceleration). Finally, we made step changes in the motor speed

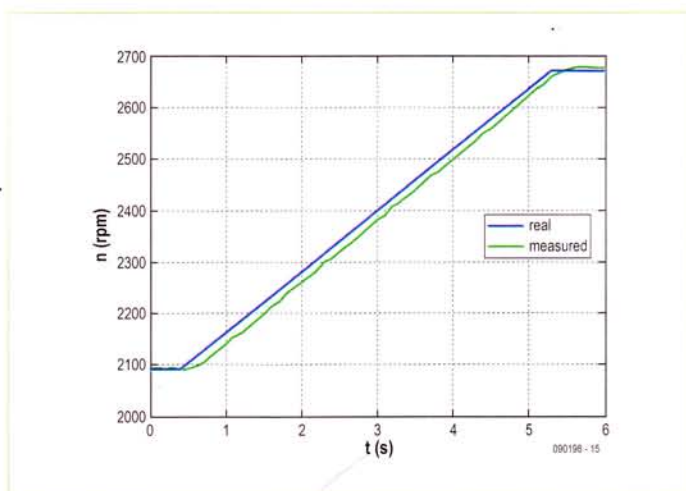

Figure 7. Linear speed change with an EMG30 motor.

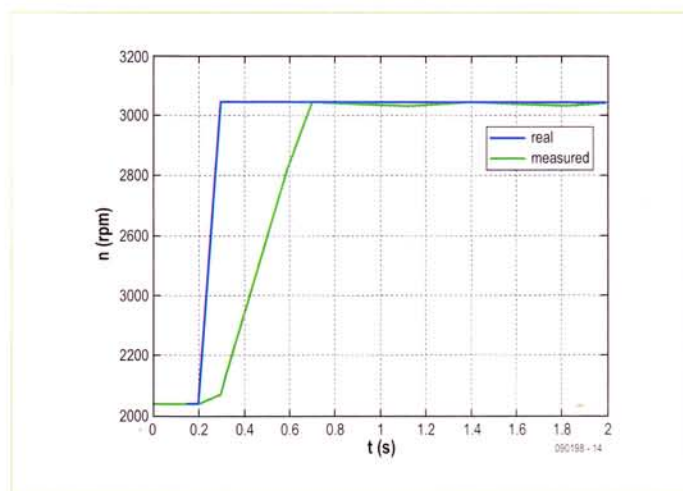

Figure 8. Step change in motor speed with an EMG30 motor.

and measured how long it took for the new speed to be indicated. The results at various speeds are summarised in **Table 2**. **Figure 7** shows the performance with linearly changing motor speed. The mean error in tracking the motor speed was 17.39 rpm in this situation, with a deviation of 8.90 rpm. The time lag for tracking the motor speed was 0.2 s, which is negligible for many applications. The error that occurred with a step change in the motor speed can be seen in **Figure 8**. The time required for the indicated speed to reach the actual speed was 0.4 s.

Conclusions

In this article, we have described a method for determining the speed (rpm) of DC motors by observing only the motor current. Although the method described here is based on a system incorporating a computer, this does not mean that it cannot be implemented in other ways. The ripple detector could also be constructed using opamps, and the other two blocks could be implemented with an inexpensive microcontroller, or with the microcontroller used to control the motor.

Various tests were performed after the system was put together. The measured performance of the system is good enough for use in a large number of applications. This method has several advantages: it is not necessary to fit any objects on the motor shaft, the risk of malfunctions is lower, and the cost of the total system is lower.

We can therefore conclude that this method forms a good alternative for measuring the speed of a DC motor under normal conditions. Multiplexing techniques could also be used with this method

to measure the speeds of several motors, which is not possible with conventional methods.

(090198-I)

Table 2. Measurement errors in the measured speed of the EMG30 motor.

Actual speed (rpm)	Mean error (rpm)	Deviation (rpm)
500	676.18	157.82
721	117.60	73.47
1023	1.86	7.91
1242	0.74	3.74
1516	0.23	5.08
2015	0.19	4.86
2514	0.30	5.75
3021	1.28	5.97
3502	1.96	7.15
4037	0.06	4.36
4492	0.50	7.31
5000	0.51	9.69
5518	1.27	11.94

About the authors

Jaime Gómez-Gil was born in 1971 in Aguilar de Bureba, Spain. He studied at the University of Valladolid, where he received a degree in telecommunication engineering in 2000 and was subsequently awarded a PhD degree in 2005. He has been employed there since 2001 as a lecturer in signal and communication theory and telecommunication engineering. His research areas are communication, GPS applications for agricultural use, sensorless technology for motors, artificial vision and augmented reality.

Ernesto Vázquez-Sánchez was born in 1985 in Plasencia, Spain. He studied at the University of Valladolid, where he received a degree in telecommunication engineering in 2008 and a degree in electrical engineering in 2010. He is currently working on his doctoral thesis. He has been employed in the Department of Signal and Communication Theory of the University of Valladolid since 2009, with a study contract as a recently graduated staff researcher. His interests and research encompass communication and sensorless technology for motors

Wireless Instrumentation Network

Measuring with Arduino and XBee

By Johan van den Brande (Belgium) (johan@vandenbrande.com)

In this article we describe how to put together a wireless instrumentation network with the Arduino platform and MaxStream XBee modules. The network uses an EtherShield module to automatically make measurement data accessible via the Internet.

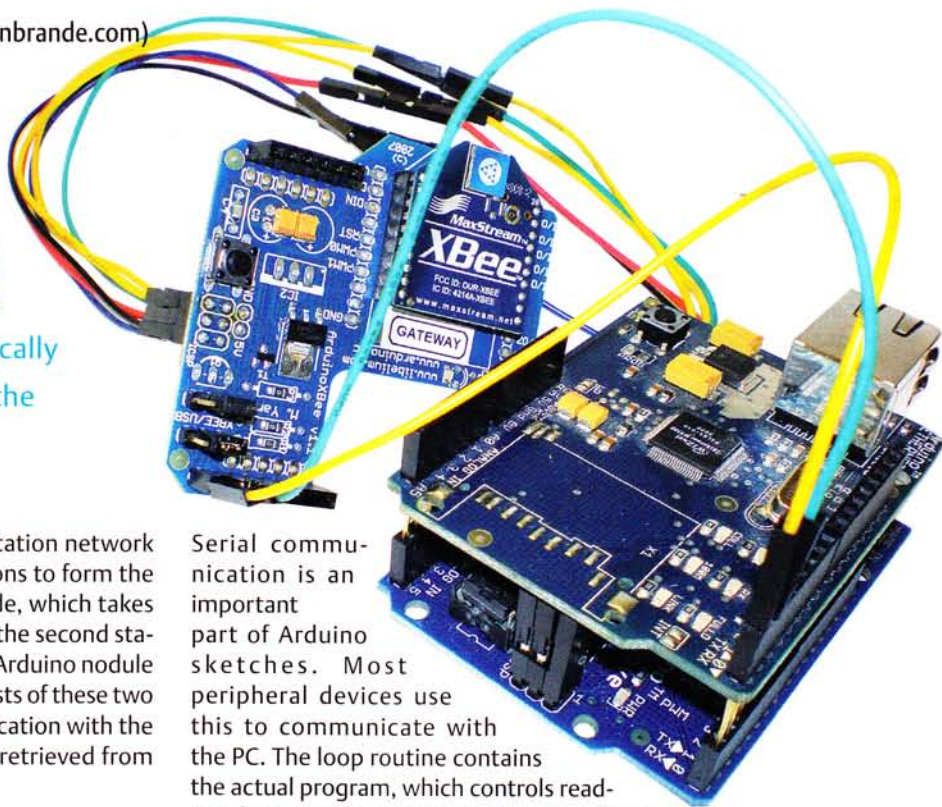

It's not difficult to construct a wireless instrumentation network with the Arduino platform. Here we use two stations to form the network (see **Figure 1**). The first station is the node, which takes readings from the sensors and sends the results to the second station, which is the gateway. The node consists of an Arduino nodule with an XBee shield module. The gateway also consists of these two modules, plus an EtherShield module for communication with the Internet. The resulting measurement data can be retrieved from the Pachube website [1].

Arduino

Arduino is an open-source microcontroller platform with a user-friendly development environment, based on an 8-bit Atmel AVR microcontroller. It is used primarily by hobbyists and artists to create interactive projects. The Arduino platform has a low entry threshold. You don't need to know how to program in assembly language or write your own boot loader. The programming language you use is a lot like C, but all of the difficult tasks such as initialising the microcontroller and communication with a PC are already taken care of. The Arduino development environment is based on a program called Processing, which is used by graphic artists to create visual masterpieces. It includes a handy library with lots of routines to help you achieve useful results quickly.

The Arduino module has several digital ports and analogue inputs. The analogue inputs utilise the A/D converter of the AVR microcontroller. Some of the outputs can be driven in pulse width modulation (PWM) mode. If you add a small RC filter, the result is a nice analogue signal. The basic functionality can be extended with modules called shields, which can be plugged onto headers on the Arduino module. Shields are available for all sorts of applications, such as video and audio, joysticks, MP3 and so on.

A program for the Arduino module is called a sketch, and it includes a setup routine and a loop routine. In the setup routine, the ports are defined as inputs or outputs and the serial port is initialised.

Serial communication is an important part of Arduino sketches. Most peripheral devices use this to communicate with the PC. The loop routine contains the actual program, which controls reading data or a signal from individual inputs, responding to the input signals, and driving the outputs.

XBee

XBee modules are a convenient way to add wireless communication to a design. The modules from MaxStream are an implementation of the ZigBee technology developed by the ZigBee Alliance, a nonprofit consortium of chip makers, technology providers, OEMs and end users. ZigBee technology is intended to facilitate the creation of inexpensive, low-power wireless sensor networks. The modules transmit data at rates up to 250 kbps over a range of 30 to 100 m, depending on the version (1 mW or 10 mW) and the ambient conditions.

The modules can be used to replace a serial communication cable, but they can also be controlled through the Application Programming Interface (API) mode to form a more complex wireless network. The modules are configured using AT commands. For serial line emulation, it is important that both modules are configured with the same network ID and the same channel (CH). By default, the MY parameter (the 16-bit module address), the DL parameter and the DH parameter are set to '0'. This means that both modules can identify each other. The DL and DH parameters specify the destination address (DL = lower 16 bits, DH = upper 16 bits). They determine the reception options. These parameters may be configured in various ways. If DH is '0' and DL is less than '0xFFFF', every module whose MY parameter matches the value of DL receives data from the trans-

mitting module. If DH is '0' and DL is '0xFFFF', every module receives the data transmitted by this module. If DH is not '0' and DL is greater than '0xFFFF', data is received only by modules whose serial number matches the destination address of the transmitting module (SH of the receiving module = DH of the transmitting module and SL of the receiving module = DL of the transmitting module).

Extension shields

In this project we use a ready-made shield called EtherShield, which provides Internet access capability for the Arduino module. It has an RJ45 connector and can be linked to a router or a switch by a UTP cable. A separate software library is available for the EtherShield module. It's usually possible to stack several Arduino shields on top of each other, as long as there aren't any conflicts between the inputs and outputs that are used. Although a standard XBee shield is available for the Arduino module, it poses a problem here because it cannot be stacked with the EtherShield module. For this reason, we developed a shield that can accept an XBee module and can also be plugged on top of the EtherShield module.

The design of our shield module is reasonably straightforward (see **Figure 2**). We included the voltage regulator because the Pro version of the XBee module can draw up to 100 mA, which is too much for the integrated regulator of the Arduino module. The XBee module also requires a 3.3-V supply voltage.

The XBee module communicates with the Arduino module via pins 1 (RX) and 2 (TX). The Arduino module also uses these pins for serial communication with the PC. As we want to be able to program the Arduino module with the XBee shield fitted, we inserted a pair of switches in the communication path. The Arduino module normally communicates with TTL-level signals on pins 1 and 2, so a voltage divider reduces the level of the input signal on the XBee RX pin to 3 V. Level adjustment is not necessary in the other direction, since the Arduino sees 3.3 V as a high level.

The PCB layout has been kept simple, and all of the components (except the pushbutton) are leaded types. The Eagle and PDF files of the PCB layout are included in the download file for this article [2].

Sensor options

We use the analogue inputs of the Arduino module in this project, which means we can use simple sensors, such as an LDR to measure light intensity. Another interesting application is measuring relative humidity. You can make a simple sensor for this by embedding two nails about half a centimetre apart in plaster of Paris inside a length of plastic pipe. Connect one of the nails to +5 V and the other to an analogue input pin and to ground via a 10-kΩ resistor (see **Figure 3**).

A lot of other quantities can be measured using the digital inputs. The number of ports can be expanded with an I²C bus device, such as the Texas Instruments PCA9535.

All together now

As already mentioned, our system consists of two stations: the node formed by the Arduino and XBee shield modules (**Figure 4**) and the gateway formed by the Arduino, XBee shield and

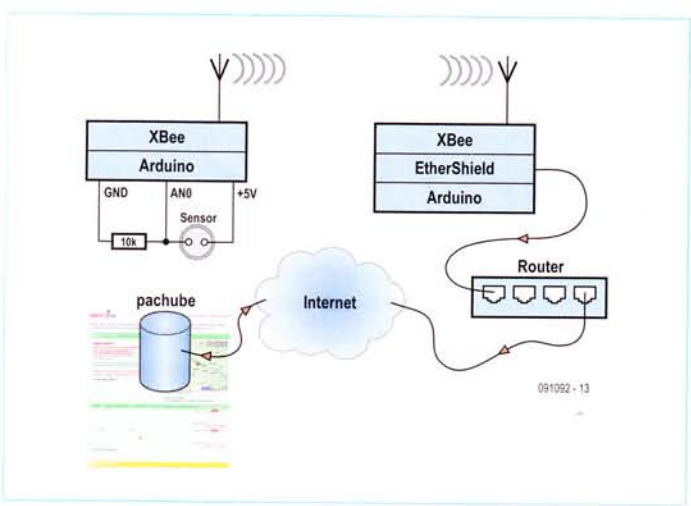

Figure 1. The instrumentation network consists of a node, a gateway and a data platform at www.pachube.com.

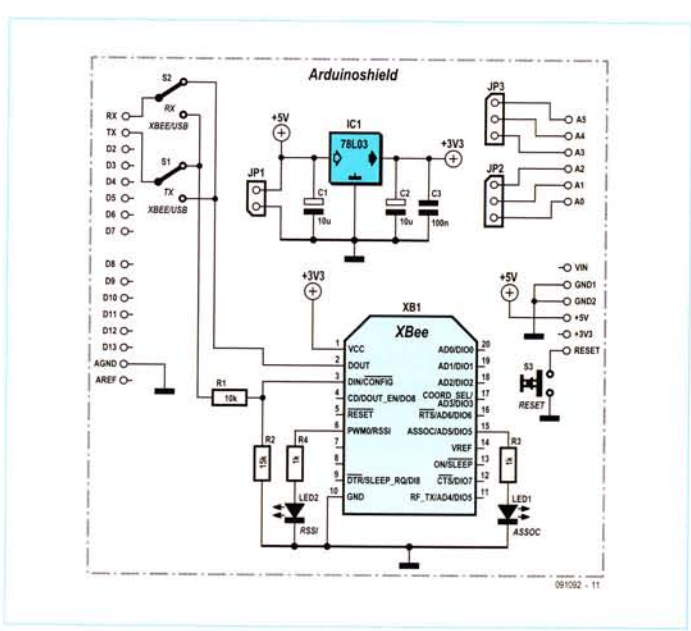

Figure 2. The schematic diagram of our Arduino shield is reasonably straightforward.

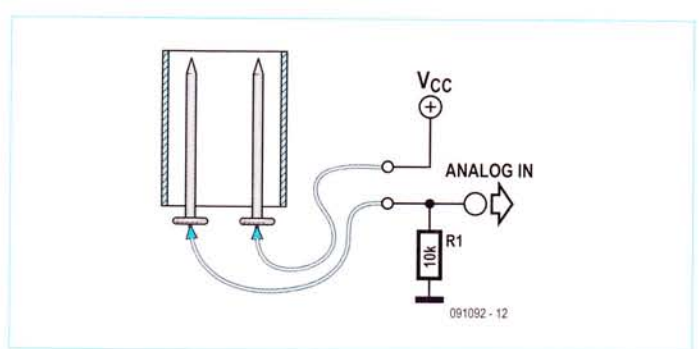

Figure 3. A simple humidity sensor can be made by embedding two nails in plaster of Paris inside a length of plastic pipe.

The Internet of Things

In the last while there's been a lot of activity related to the 'Internet of Things', which means connecting everyday objects to the Internet. Sensor data platforms such as the Pachube website are a good example of this. On this site you can store and retrieve sensor data for purposes such as displaying a chart or maintaining a log. Another potential application is monitoring sensor values and performing a suitable action if they exceed a defined level, such as sending an e-mail or text message. Pachube is a publicly accessible site with a simple protocol for sending data to the site. You can assign geographic coordinates to your sensors, which are then shown on a map of the world. The data can be viewed in the form of charts, and you can also grant other people access to your data. Instead of sending data directly to other parties, you can publish it once on the Pachube site, where other parties can subscribe to receive your data stream.

After registering on the Pachube site, you have to create a feed. You should click 'Manual update' when you configure your feed, since this allows the microcontroller to determine when to publish new data. With the other option, 'Automatic', the Pachube site actively sends Web request commands to fetch the data. To make this possible, you would have to embed a web server in the microcontroller and configure your network to allow access to the microcontroller from the Internet. After you create your feed, you are assigned an API key.

The microcontroller uses the HTTP protocol for manual updating. This is a very simple text-based protocol that supports the usual task of retrieving data (GET command), as well as sending data (PUT command), modifying data (POST command), and deleting data (DELETE command).

An HTTP request consists of a header and a body, separated by a blank line. The first header line contains the protocol version, the command

type (GET, POST, PUT or DELETE) and the resource, which is where the command is supposed to do its work. It may be followed by other header lines that supply various parameters to the web server, such as the type of content your client is able to process. A header line consists of a name and value. For the application described in this article, the API key belonging to the feed is placed in a header line.

The header is followed by the data. The following is an example of a PUT request to the Pachube website:

```
PUT /v2/feeds/ENTER_FEED_ID_HERE.csv HTTP/1.1
Host: api.pachube.com
X-PachubeApiKey: ENTER_YOUR_PACHUBE_API_KEY_HERE
Content-Length: 10
Connection: close
```

```
0,100
1,244
```

The HTTP protocol is easy to implement in a sketch (an HTTP-based protocol of this sort is called a REST API). It is even possible to test the adaptation of the feed from the console, for example with the *curl* command:

```
curl --request PUT --header "X-PachubeApiKey: YOUR_API_KEY" --data "0,100" "http://www.pachube.com/api/feeds/YOUR_FEED_ID.csv"
```

The *curl* function is available in the standard OS X installation and can easily be installed under Linux. Windows users can download it from <http://curl.haxx.se/download.html>.

Firmware

This brings us to the firmware, or as it is called, the sketches. The sketch that runs in the node (see the program code in the download package [2]) is the simplest. Briefly, it waits for a certain time, takes a snapshot of the analogue inputs, and sends it via a serial link to the XBee module. The following description is based on the program listing with line numbers provided in a separate document.

The time interval for reading and forwarding the measurement data is specified in line 10. Here it is set to 5 seconds, which is the shortest allowable interval for sending data to Pachube with a non-professional account. Line 11 assigns a unique name to the node. This name is not used at present, but you could use it in the gateway to distinguish between different nodes. In the *setup* routine, the transmission rate is set to 9600 baud in line 42 (the standard value for the XBee modules). Furthermore, serial communication is configured to 8 bits, no parity and 1 stop bit without any additional parameters. The *loop* routine is fairly simple. It calls the *intervalPassed* routine, which determines whether the configured interval (5 seconds) has expired. If it has, the *measure* routine is called. First we send the name of the node to the XBee module (lines 29 and 30), followed by a colon (:). The *for* loop in lines 32–35 polls all of the analogue ports and sends their values to the XBee module (line 32). Line 34

EtherShield modules (**Figure 5**). Plug the EtherShield module onto the Arduino gateway module first, and then plug the XBee shield module on top so its pins and switches are readily accessible. Set both switches in the USB position when you want to program the Arduino module, and set them to the XBee position when you want to transmit or receive data with the XBee module. If you only want to receive data from the XBee module, set the RX switch to the XBee position and the TX switch to the USB position. This allows you to display IDE debug information on the serial port console of the Arduino module. It may be convenient to fit the board with headers with jumpers instead of switches so you can open the TX signal path between the Arduino and XBee modules, which is handy for debugging.

XBee modules must be properly configured in order to communicate with each other. They are supplied with a factory default configuration for operation in serial line emulation mode. You can configure them by using the terminal emulator utility in a Windows, Minicom or Linux environment to send them Hayes AT commands, or by using the X-CTU software supplied by MaxStream [3]. This does not require any special hardware. Set both switches to the USB position and unplug the AVR microcontroller from the Arduino module. Now you can use the USB link to communicate with the XBee module via the PC.

inserts a comma after each analogue value (except the last one) to separate the values. Line 37 finishes off with a new line. The sketch for the gateway is more complex because it also looks after the Internet link to the Pachube website (see inset 'The Internet of Things'). The gateway waits until a full line has been received from the serial link and then sends the name of the measurement method and the sensor values to the Pachube site.

Before using this sketch, you must edit it to have the right parameter values for your Pachube account and network. In line 13, enter the ID of the feed you have created, and in line 14, enter your API key (from My Profile > Settings at [1]). Connect the gateway to a router or switch so it can access the

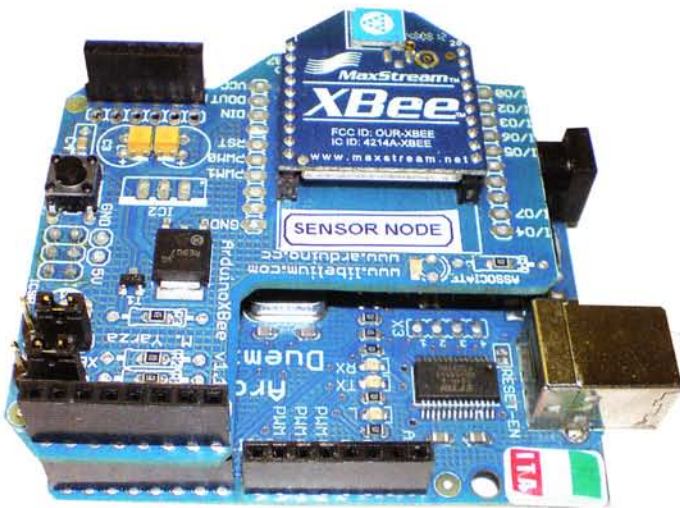

Figure 4. The node for reading the sensors consists of an Arduino module and an Xbee shield.

Internet directly. Configure the network parameters in lines 16 to 18 by putting the MAC of the EtherShield module in line 16 and its IP address in line 17. A MAC address identifies a specific device in an Ethernet network. You can use nearly any value you want for the MAC as long as it does not cause a conflict with other devices connected to the router or switch. Choose an unused IP address in the address space of your local area network and enter it in line 17. Here you must replace the dots in the IP address with commas, since the code in lines 16–18 defines a set of arrays. The IP address of the Pachube site is specified in line 18. In more elaborate software you could use the Domain Name Service (DNS), which translates domain names into IP addresses, but the approach used here is adequate for our purposes.

Line 20 allows you to set a debug flag that activates the `_LOG` macro in line 23. This macro first reserves 256 bytes on the stack

AFFORDABLE EXPERTISE

THE PC OSCILLOSCOPE RANGE FROM PICO TECHNOLOGY

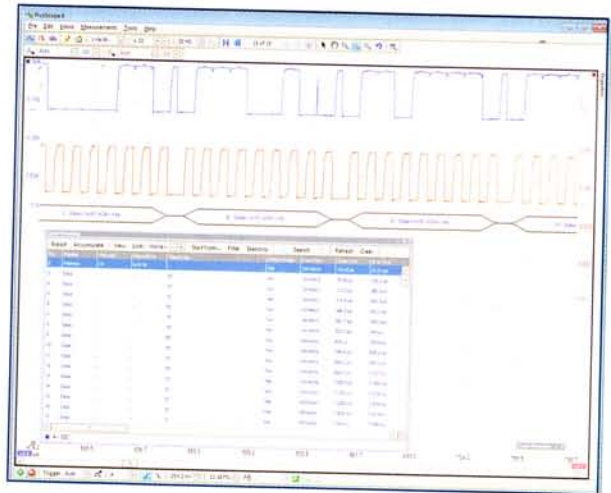

BANDWIDTH
20 MHz to 12 GHz



SAMPLING RATES
50 MS/s to 5 GS/s



MEMORY
8 kS to 1 GS

RESOLUTION
8 to 16 bits

PRICES
£125 to £6995

Latest Software Updates: I²C & CAN bus decoding, mask limit testing, advanced triggers, digital low pass filtering, rapid triggering

www.picotech.com/scope2023

READER'S CIRCUITS

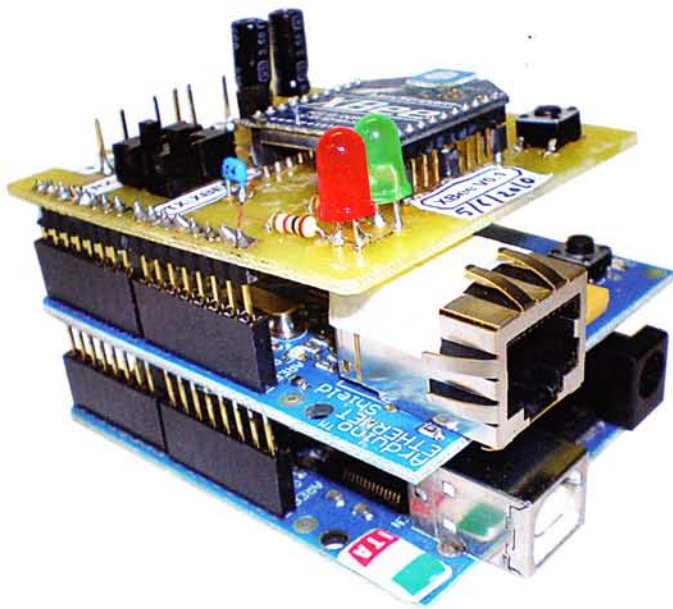

Figure 5. The gateway, with an adapter board that allows the XBee shield to be used together with an EtherShield module.

as a C string in the *m* variable. This is followed by a formatted print command (*snprintf*) for this string. Like the *printf* (and *snprintf*) function, this macro can receive a variable number of parameters. This is indicated to the compiler by the ellipsis (...) in the macro definition. The construction `##_VA_ARGS_` expands this variable number of parameters in code that calls *snprintf*. If you disable the debug function by commenting out line 20, the `_LOG` macro is expanded to nothing (line 25).

Lines 27 and 28 link in the *Ethernet* library. This library is necessary for using the EtherShield module. The *string* library (line 29) is necessary for *snprintf* and *strncat*, among other things.

Line 30 specifies that six sensors will be read, and lines 31–34 define the *sensor* structure. The data received from the remote sensor is transformed to this structure. Line 35 creates an EtherShield client object: the TCP client, which establishes a connection to *server* on port 80 at the Pachube IP address.

The core of the sketch is the *loop* function in lines 103–112, which runs reiteratively. Lines 105 and 106 define a character buffer (*buf*) for the data read from the remote node. The data is read in by calling the function *readRemoteSensors* (line 109). After a full line has been received, it is analysed in line 110. The *parse* function converts the data to the *sensor* structure. The *pachubePost* function in line 111 sends the converted data to the Pachube site.

The *readRemoteSensor* function defined in lines 85–97 reads data from the serial port and places it in the buffer (*buf*) until the 'new line' character `\n` is received or the buffer is full (*while* loop at line 90). Line 91 checks for new data on the serial input. If new data is present, it is read in line 92 and placed in the buffer, and the buffer pointer *i* is shifted one position to the right. When all the data for the buffer has been read, the routine sets the current buffer location to '0' and exits.

The *parse* function in lines 67–84 uses the *strtok* function to analyse the data in the *buf* variable. It split the string each time it encounters any of the characters defined in the *sep* (separator) variable, which in this case are the colon (:) and comma (,) characters. The *strtok*

function returns the next token or character each time it is called. As a result, when the *for* loop in lines 78–82 has completed execution, the full line has been analysed and the corresponding sensor values are located in the *sensor* structure. The *atoi* function converts an ASCII number to an integer value.

The connection to the Pachube site is established by the *pachubePost* function (line 36). It receives the *sensor* structure as an input parameter. The name is not used, but you could use it to select a different feed. Lines 42–46 convert the sensor values into comma-separated values. The format consists of the sequential number of the sensor and the value, separated by a comma. Each sensor is on a separate line.

Lines 49–61 handle the actual data transfer between the gateway and the Pachube site. Line 49 establishes a connection to the Pachube site at the TCP level. Once this connection is available, the *print* and *println* functions can send data to the Pachube site. Line 52 outputs a PUT command to Pachube, along with the feed name (*FEED_ID*). The data is sent as a CSV file, which is why the key has the `.csv` extension. The HTTP 1.1 protocol is used for this. Several header lines are sent as well. Line 53 sends the *host* header line, which indicates that the data is intended for the `pachube.com` host. This construction allows more than one domain to be hosted from a single IP address. Line 54 sends the API key. Pachube uses this unique key instead of a user name and password. Line 59 terminates the header with a blank line, after which the sensor data is sent by line 60. The data length must be the same as the value stated in the *Content-Length* header. After this operation, the feed has been supplied with new data and the current values and history can be retrieved from the Pachube website.

Final remarks

It's easy to put together a wireless instrumentation network with MaxStream XBee modules linked to Arduino modules. Serial line emulation allows data to be sent and received relatively easily. An EtherShield module handles the connection to the Internet. Although it is possible to use more than one sensor node, you have to watch out for interference when two nodes send data at the same time. It's therefore better to switch to API operation and configure a mesh network or star network. This requires considerably more complex software, although the hardware remains the same.

(091092-1)

Internet links

- [1] www.pachube.com
- [2] www.elektor.com/091092
- [3] www.digi.com/support/kbase/kbaseresultdetl.jsp?kb=125
- [4] www.arduino.cc/en/Main/ArduinoXbeeShield
- [5] www.ladyada.net/make/xbee/arduino.html
- [6] www.faludi.com/projects/common-xbee-mistakes
- [7] www.adafruit.com/index.php?main_page=product_info&cPath=29&products_id=126

Portable Energy

For cell phone, iPod and co.

Harry Baggen (Elektor Netherlands Editorial)

These days we all carry a whole array of portable devices along with us. Very handy, but those mobile phones and MP3 players have to be recharged frequently and a convenient power point is unfortunately not always at hand. Fortunately there are a multitude of alternative energy sources available, or so manufacturers have us believe...

Tug-of-war

The Universal Mobile-device Charger made by Yogen uses hand power to generate electrical energy. The idea is ancient: You pull a rope to get something else to rotate, in this case a kind of miniature flywheel. Add some electronics to regulate the voltage and a handy power cord with different adaptor plugs, and your universal hand-powered charger is complete. It does, however, not mention anywhere how long you have to

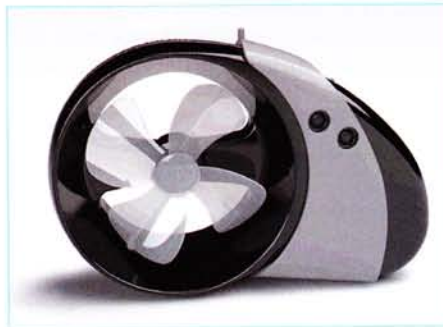

If there is no wind then you can charge the battery from a wall socket using the supplied adaptor. Available in three colours, the unit is priced at around \$50. All sorts of mounting hardware is available separately.

www.hymini.com/html/HYmini.html#detail_1

Versatile radio

Radios without a battery, but with a handle for generating energy by hand, have been around for years already. But the SOLARlink FR600 from Etón is a very fancy and versatile implementation of this concept. You



can power the radio using either the handle, a built-in solar panel, three batteries or an AC power adaptor. To store energy, the radio has a built-in NiMH battery. The digital AM/FM tuner has a display with RDS and the device can also operate as a torch. The built-in battery can also be used to charge your mobile phone or other portable equipment. Price is about \$80.

www.shopetoncorp.com/detail/ETO+NFR600B+BLK

Mini-hydrogen power station

The Hydrogen Power Station made by Horizon Fuel Cell Technologies is the first affordable mini-hydrogen power station for use at home. The hydrogen, which is generated using solar energy, is stored in small tanks, so-called Hydrosticks, which



have dimensions similar to a battery. A full Hydrostick can be plugged into a small power generator which goes by the name of MiniPAK and can generate about 2.5 watts. The amount of hydrogen in the Hydrostick is sufficient to completely recharge a depleted mobile phone battery several times. The only thing standing in the way of purchasing this handy device



pull the cord before your phone is charged up. Available in black and transparent plastic — expect to pay around \$50.

www.yogenstore.com/index.html

Gust of wind

With the HYmini wind generator you can generate energy while cycling or jogging. Mount the device on your upper arm, or on the handlebar of your bicycle or scooter. Depending on the force of the wind, the built-in Li-ion battery, rated at 1200 mAh, is charged slower or faster. Afterwards this energy can then be used to charge your mobile phone or iPod.

PORTABLE ENERGY



is probably the price, which is around the \$750 mark.

www.horizonfuelcell.com/electronics.htm

Sturdy dyno-torch

Who does not remember them from the past? This type of torch, which required repeated squeezing to get some light, is available these days in modern, high-efficiency versions. The Shark Diving Torch is a waterproof torch fitted with a generator which produces energy when cranking the handle. This energy is stored in the built-in battery and can be used to power the built-in LEDs or charge your mobile phone. The torch is fitted with several standard LEDs plus a powerful 1-watt LED, so that a considerable amount of light is available. The manufacturer claims that after one minute of cranking the handle, the battery will have sufficient energy to power the 1-watt LED for 20 minutes, a respectable time! Price about €35 (£30, \$50).

http://shop.ecogadgets.com/index.php?cat=Eco_Torches_Lanterns&ActionID=df7232c6bab7b44952aef49dca635420

http://shop.ecogadgets.com/index.php?cat=Eco_Torches_Lanterns&ActionID=df7232c6bab7b44952aef49dca635420



Walking is healthy!

Using the nPower PEG you can charge practically any mobile phone, MP3 player or any other hand-held device while you walk. The device is in the shape of a pipe with a bulge in the middle. Put it in your backpack or attach it to your belt. As a result of the repetitive motion of your body the nPower PEG produces sufficient electricity to quickly charge your mobile phone — says the manufacturer Tremont Electric. A normal phone battery can supposedly be charged to 80% of its nominal capacity in only one hour. The device is able to deliver no less than 4 watts.



You can register your interest at the manufacturer's website, but the exact date it becomes available is not known. The price is around the \$150 mark.

www.greenpower.com

Pumping for a full battery

The companies Gotwind and Orange present an alternative method to charge the battery of your mobile phone or iPod, the Power Pump. This is a small wind generator where you generate the wind yourself using a foot pump. Handy while going camping, and thanks to its small dimensions it is unlikely not to fit in your backpack somewhere! Orange presented this device last



year at the Glastonbury Festival, where visitors could try it for themselves. As far as we know the device is not yet available for sale.

www.gotwind.org/orange_power_pump.htm

Batteries on water

For a number of years already the Japanese manufacturer APS (Aqua Power System) has been offering AA and AAA batteries which work using water, juice, coffee or other liquids. When you want to use a battery you fill it with a few drops of liquid and it is immediately ready for use. You can re-fill the battery about 10 times, according to the manufacturer. The second generation of the so-called NoPoPo-batteries is now in production and D-size cells will be available soon as well. Not really energy saving, but nevertheless very alternative. Perhaps they will also be available in US and European shops in the near future.

www.aps-j.jp/english/index.html

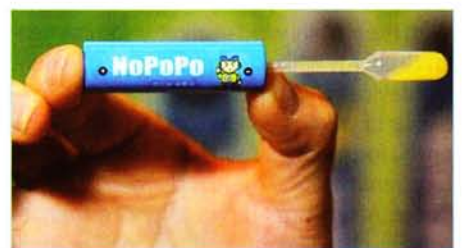

JTAG Live Buzz

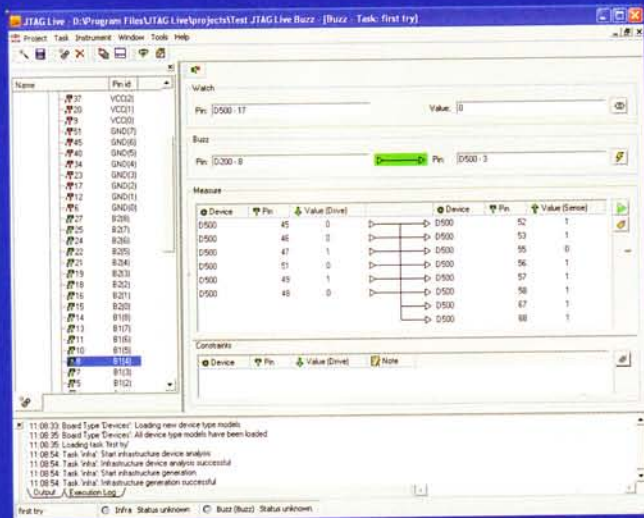
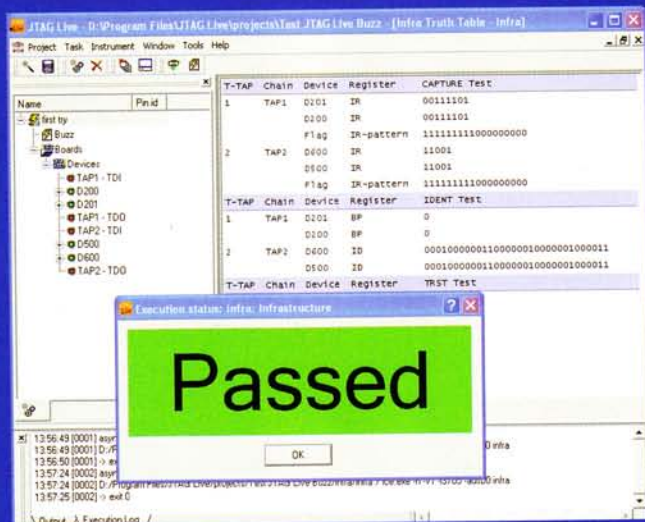

By Luc Lemmens (Elektor Labs)

For most of us, the term 'JTAG' primarily means an interface for in-system programming. Few people realise that it also refers to a test method called 'boundary scan', and even then they probably couldn't say exactly what this means. As early as the 1980s it became clear that traditional measurement methods using instruments such as multimeters and oscilloscopes would eventually become unfeasible due to the ongoing miniaturisation of electronic devices. Multilayer PCBs went mainstream, with the result that many interconnects were inaccessible, and with modern components (such as BGA packages) it is often impossible to put a probe on device contacts. To deal with this problem, JTAG developed the boundary scan method. Of course, in-system programming is also important, and it can be done using the same JTAG interface.

Boundary scan requires adaptation of the IC architecture. A boundary scan cell is added, containing a multiplexer and a latch for each pin of the device. This cell can read data from each pin or read logic levels from signals originating from the core of the device, and it can place data on the pins of the IC. The data that is read is output serially from the IC and compared with the expected result.

In practice, the boundary scan cells of several ICs are connected in series to form a scan path or scan chain. The first IC in the chain receives JTAG data directly from the interface connector on its TDI (Data In) pin, while its TDO (Data Out) pin is connected to the TDI pin of the next IC in the chain. Finally, the TDO pin of the last device in the chain is connected back to the

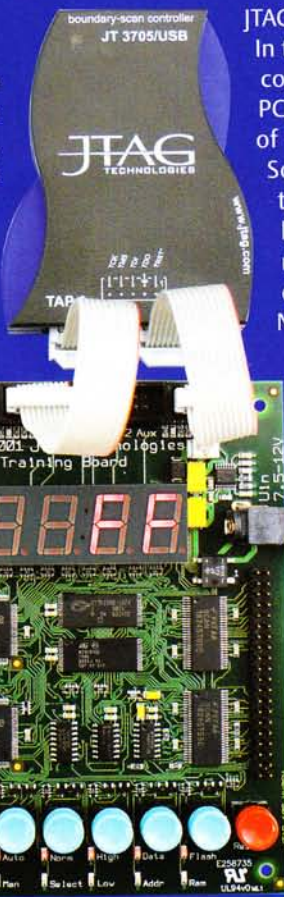

JTAG interface connector.

In theory, with this arrangement a complete connectivity test of the components on the PCB can be carried out, based on the netlist of the complete circuit and the Boundary Scan Description Language (BSDL) files of the components. In practice, there are limitations because some components do not have boundary scan capability – for example, passive components and buffers. Nevertheless, the majority of the PCB can be tested for open connections and shorts with this method.

To familiarise (potential) users with boundary scan technology, JTAG Technology [1] offers the free program JTAG Live Buzz. The functionality of this program can also be enhanced with the Clip and Script modules, which require payment.

To work with JTAG Live, you also need a JTAG pod and a PCB with a boundary scan chain, as well as the schematic diagram and the BSDL files of the components on the board. For our hands-on evaluation of JTAG Live Buzz, we were provided with two scan chains and a USB boundary scan controller with two JTAG taps.

The first thing JTAG Live needs to know is the configuration of the scan chains, for which you need to know which type of JTAG controller you have and which ICs are in the chains (and in which sequence). The ICs are characterised by their BSDL files. Once all this data is complete, the real work can begin.

After everything is connected, the first thing you have to do is to select 'Test Infrastructure', which causes JTAG Live to

check whether the scan chain is correct and works properly. Beside configuration errors, there may be a bad connection or a short in the chain, which will prevent the boundary scan from working. If everything is OK the message shown in **Figure 1** is displayed, and you can continue with the functional testing of the rest of the hardware.

The actual measurement process starts with 'Open Buzz'. The inputs and outputs of the ICs in the scan chain are listed in the column on the left in **Figure 2**. You can drag them one by one to the measurement panels in the window.

The 'Watch' panel lets you observe the state of an IC input. In the example shown here, this is an input of a CPLD (pin 17 of D500), which is driven by a switch on the demo board. The 'Value' field shows the current logic state of the selected input in real time. This allow you to check whether the connection between the switch and the IC is OK.

The 'Buzz' panel lets you check a connection between two pins of ICs in the scan chain, which is comparable to conventional continuity testing with a multimeter.

The 'Measure' panel offers tests similar to the 'Buzz' panel, but with the added feature that you can directly set the state of an output to 0, 1 or HiZ in the 'Value (Drive)' column. In this example, a 74138 (decoder/demultiplexer) is located between

the outputs of D5000 (left column) and the inputs in the right column, and it is not included in the scan chain. This function allows the operation of this IC to be checked, despite this fact.

The 'Constraints' panel allows you to cause specific control signals on the PCB (such as Chip Select or Output Enable) to assume defined states for the tests in the 'Measure' panel.

Although all of this may not sound especially spectacular, you should bear in mind that here we are performing tests with a PC that would be difficult or impossible with a multimeter or oscilloscope, for the simple reason that the connections on the PCB are not physically accessible to a probe. The boundary scan method allows the hardware to be tested (for the most part) despite this difficulty.

The Buzz program is solely intended to demonstrate the power and simplicity of boundary scan technology. With complex hardware, it would be far too cumbersome to enter and check each connection by hand, which is why you would need the resources of the more powerful JTAG Live modules Clip and Script.

(100590-1)

Internet Links

[1] www.jtag.com

USB port from a 9-pin Sub-D connector



By Ernst Krempelsauer (Elektor Germany Editorial)

The company FDTI specialise in products providing interconnection solutions. At first glance their latest offerings look like standard 9-way sub-D RS232 PCB mount connectors and indeed fit the hole-spacing for such a connector on a PCB. A closer look reveals a mini-B USB socket where the RS232 cable should plug in! For sure there must be a lot more in the plastic housing than just 9 bent wires. These novel converter/connectors allow a USB port to be easily added to any PCB fitted with an RS232 connector. No layout, circuit or firmware changes are necessary. The unit on test here is the female sub-D version; a male version is also available.

Elektor readers familiar with the USB to RS232 cable from FTDI will probably be thinking that the engineers have fitted the same circuit into the RS232 connector housing. The block diagram in **Figure 1** confirms this, two ICs are shown: an FT232R converts between USB 2.0 and serial TTL data and a voltage level shifter interfaces TTL and RS232 levels.

With the first sample sitting on the work bench we looked for a suitable PCB to adapt. The Elektor Internet Radio project (April 2008) looked like a good candidate; among its connectors is an RS232 de-bug port using a sub-D PCB mounted 9-way connector, perfect! We set to work de-soldering the sub-D and

then mounted the FTDI USB Sub-D male module (it fits!). Next we plugged a USB cable into the socket (needs a bit of coaxing to get it all the way home), switched on and connected to a PC. The FTDI driver practically installs itself; you only need enter a virtual COM port number and select a baud rate.

The FTDI data sheet gives more details of this procedure and the function of the device. It behaves in exactly the same way as if the USB/RS232 converter cable from FTDI had been plugged in to the original 9-way RS232 port on the board. A disadvantage of fitting the DB9-USB-RS232 module is that if you ever need to communicate with the board via an RS232 port it would be necessary to swap the connector back again. The advantage however is that the equipment now has a new lease of life and can connect to any modern PC using a standard USB cable.

Speed is another advantage, the virtual COM port driver software can be configured to operate at up to 921,600 Baud. Ensure that the board can make use of the higher data rate by changing the port configuration or modifying the firmware as necessary.

Natural curiosity prompted us to pop the cover of the housing and check out the internals

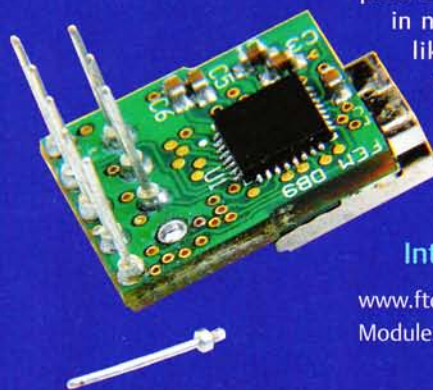
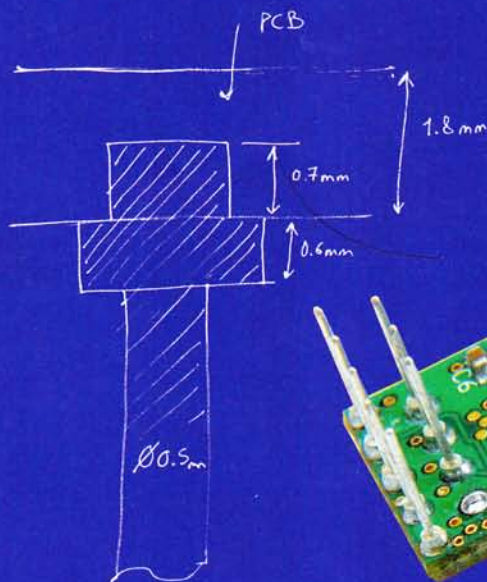
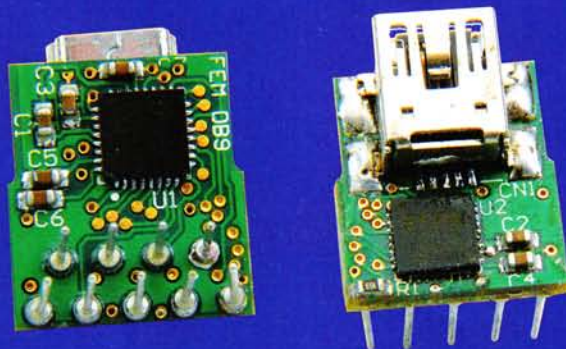
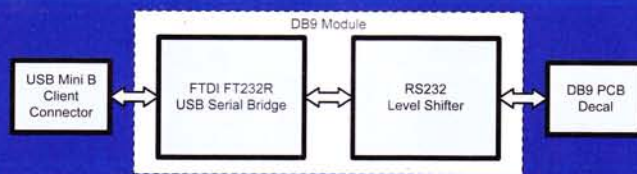

of this device. The complete PCB now lifts out for closer inspection. The manufacturing process is not quite as trivial as we might have expected; the nine pins of the sub-D module are soldered from one side of the board only (the component side). The pins do not extend through the PCB but instead are fitted into blind holes ('buried via') which extend approximately 0.5 mm into the PCB. Our Lab manager Antoine Authier removed one pin with a soldering iron and has sketched the approximate dimensions.

The more-complex manufacturing process is reflected in the price of the unit which works out a little bit more expensive than the cheapest USB/RS232 converter cable from FTDI. I can't imagine a quicker or more simple method (excluding the use of an USB/RS232 cable) of providing an older piece of kit with an up-to-date comms port. It can of course be used in new designs also and like all good ideas it makes me wonder why nobody thought of it before.

(100104)

Internet Link

www.ftdichip.com/Products/Modules.htm

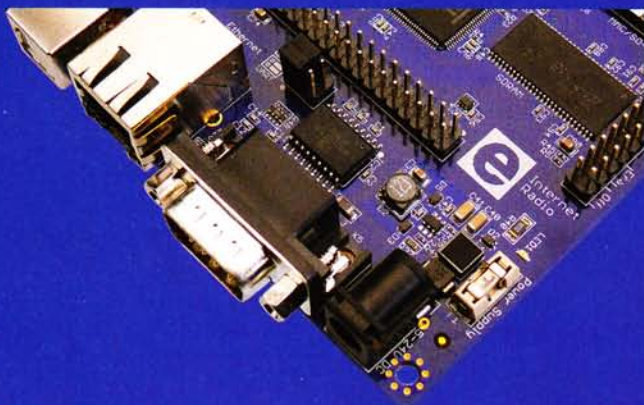

Rapid Prototyping

By Jens Nickel (Elektor Germany Editorial)

After you've drafted the schematic, there comes a step in the design process that many electronics enthusiasts and professionals don't enjoy at all: putting together the bill of materials and the time-consuming process of ordering the components. This despite the fact that the day-to-day work of designers frequently involves the same mundane tasks, such as providing a regulated supply voltage, equipping a microcontroller board with a USB interface, or integrating a display.

The aim of the AutoFAB system from the Dutch tool foundry Muvium is to solve this problem by adding another level of abstraction [1]. The system is based on small PCB modules called FlexTiles, which provide commonly used circuit functions. For example, there is a FlexTile module with a dual 5-V power supply, a module with two potentiometers, a module with an LCD, a module with an FT232, and many more. Intelligence is provided by FlexTiles fitted with a PIC microcontroller, and an Arduino-compatible module is also available.

Unlike similar modular systems, all modules in this system have the same width and are fitted with pins facing downward. This allows the FlexTiles to be plugged into a special breadboard called the Flex Router board, similar to a perforated prototyping board.

When a FlexTile module is plugged in, each of its contact pins is connected to a row of solder pads on the Flex Router board. The system also has a board of the same size with tracks perpendicular to the rows on the Flex Router board, which is secured to the latter board at the end of the process. The clever part of this scheme consists of small contact pins fitted between these two boards, which allow the contact rows for the module pins to be connected to the tracks on the rear board. For example, if the module pin is the output of a 5-V voltage regulator, a 5-V supply voltage will be available over the length of the connected track. Using additional contact pins, other modules can be connected to this track to supply them with power.

Based on our experience with an evaluation system, the hardware (which is being regularly extended with additional modules) is well made, although working with the small metal pins is somewhat fiddly. Nevertheless, the result after the two boards are screwed together is a prototype that is very robust and compact, since it lacks the interconnect wiring of a conventional breadboard.

There's even more to the story. The latest version of the free Virtual Breadboard (VBB) software — a simulator program from the same supplier, which has been available for some time already — also supports virtual design with the AutoFAB boards. For this purpose, virtual FlexTiles are selected from a list and plugged into a simulated Flex Router board on the computer. At the press of button, the software imports the components into the simulator. As usual with programs of this sort, you use the mouse to connect the component in this view, after which the resulting circuit can be simulated. An especially unusual feature here is that you can program the microcontroller in Java, which is converted into executable hex code by a special compiler [2]. Of course, it takes a certain amount of time to master the simulator's learning curve.

If you are interested in this concept, we recommend attending a workshop to be held during the Elektor Live! event in Eindhoven, The Netherlands on November 20, 2010 [3]. During the workshop, Muvium CEO and principal engineer James Caska will demonstrate how quickly prototypes can be developed using AutoFAB and the Virtual Breadboard system.

A brand-new development here is a stripped-down version of the virtual breadboard concept, which runs in any browser environment (Java required) and is specifically tailored to the AutoFAB system [4]. After you have

placed the FlexTiles on the virtual Flex Router board, you use the mouse to interconnect the pins in a sort of schematic view. However, this version lacks the simulation function.

Once the connections have been made, both programs allow you to view the rear of the Flex Router board to see where the metal pins must be fitted. All you need to do now is to copy this on the real hardware. This means that putting together a prototype still requires some manual effort, which may disappoint users with poor eyesight or clumsy fingers. The ideal solution (for lazy users) would be a small software configurable component that inserts the pins for you, so you can enjoy a cup of coffee while it interconnects the rows and columns.

(100413-1)

[1] www.virtualbreadboard.com

[2] www.muvium.com

[3] www.elektorlive.nl

[4] www.virtualbreadboard.com/diky/diky.html

“Elektor? Prescribed reading for our R&D staff because that’s where we need professional guidance for microcontroller technology.”

– Frank Hawkes, 39, development engineer –



Select your own
subscription at
www.elektor.com/subs

Electronics at all the right levels

Secure a head start in electronics
with a **subscription!**

Advantages to subscribers

- Cheaper than 11 issues from the newsstand
- With every issue subscribers get up to **40% discount** on selected Elektor products
- Free welcome gift of your choice with an annual subscription
- No queues, travelling, parking fees or 'sold out'; Elektor is supplied to your doorstep every month
- Always up to date – read your copy before everyone else

www.elektor.com/subs · Tel. +44 (0) 20 8261 4509

Or use the subscription order form near the end of the magazine.

elektor

Image Processing Made Easy

Motion detection with a webcam

By Jens Nickel (Elektor Germany Editorial)

An Elektor issue with a focus on sensors is hardly complete without an article on image processing. However, this highly interesting field is widely regarded as enormously complex. This is by no means true, as we demonstrate here with a simple example. A webcam and a few basic algorithms are all you need to get started.

As already clearly demonstrated by the article 'Vision System for Small Micro-controllers' [1], you don't need expensive hardware to implement a simple presence detection system or similar application. Our objective here is to show that the software also does not need to be overly complex. A small experimental program demonstrates a basic approach to implementing a simple motion detection system. All it takes to show that everything works is a PC, a webcam and a free software development environment, such as Visual Studio Express.

From the idea ...

It all started on a Friday afternoon when the author was reading through a book on computer vision in search of inspiration for this topic. In addition to the theory, this book discusses the practical aspects of image processing in detail, including motion detection and object recognition. Suitable algorithms are presented in pseudocode, which makes it easy to implement them in the programming language of your choice. The author thought it would be a good idea to try this in Visual Basic, which is especially familiar to many readers. While reading the first practical example for motion detection (for purposes such as detecting an unauthorised visitor), the author — an enthusiastic programmer — could hardly wait to get his hands on a keyboard. He already had the Basic-language version of Visual Studio Express (available free of charge) installed on the computer, so it took only two or three hours to program the necessary algorithms for motion detection and a simple user interface. To quickly check everything out, he used the editorial department's digi-



Figure 1. Two original images to be compared

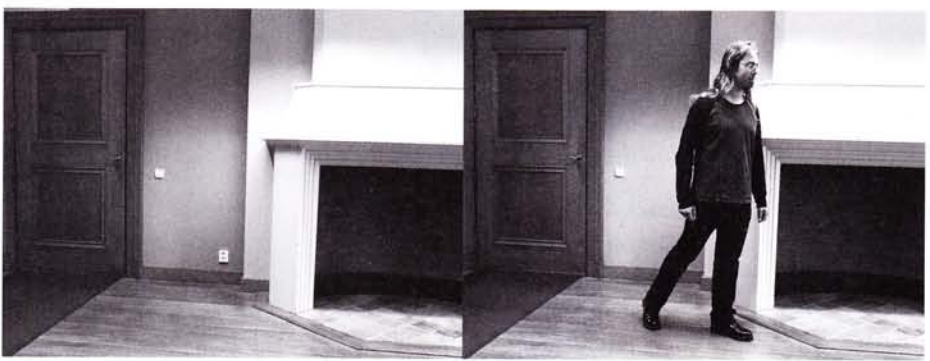

Figure 2. Greyscale versions of the original images.

tal camera to snap a couple of pictures, with a chair shifted by a small distance in the second photo. And lo and behold, it worked: the approximate size and location of the moved object could be detected by image comparison.

... to the software

Here's how it works. First the program has to get its hands on the colour data of the

individual pixels. In modern versions of Visual Basic (2008 and 2010) supported by the .NET framework, this is fairly easy. After an image file (in *.bmp* or *.jpg* format) has been loaded as a bitmap image with the name *pic*, the colour data of an individual pixel can be accessed with the following commands:

```
intR = pic.GetPixel(intX, intY).R
intG = pic.GetPixel(intX, intY).G
```

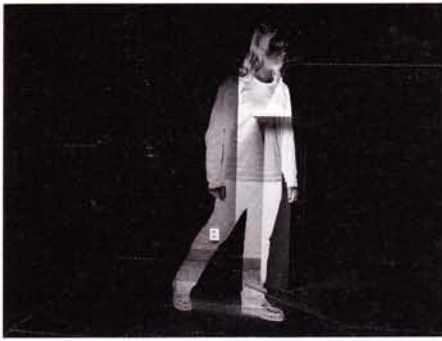



Figure 3. The difference image produced by pixelwise greyscale value subtraction and discarding negative values.



Figure 4. The result of the next step: the pixels in this image are white where the greyscale difference is greater than a defined threshold.

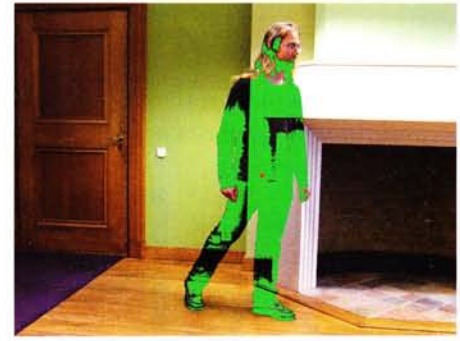

Figure 5. Here the detected pixels have been melded with the original image. The red spot marks the centre of mass of the detected motion.

```
intB = pic.GetPixel(intX, intY).B
```

Here *intX* and *intY* are the pixel coordinates, and the variables *intR*, *intG* and *intB* are assigned the values of the colour bytes for red, green and blue (value range 0–255). For motion detection we can restrict ourselves to the greyscale value of each pixel, which can be obtained in a straightforward manner from the colour data:

```
intGrey = (intR + intG + intB) / 3
```

Pixel by pixel comparison of the greyscale values suffices for a simple image comparison. This is done by synchronously iterating over all pixels. To avoid potential problems, both images should have the same size (*intX* range: 0 to *intXmax* – 1, *intY* range: 0 to *intYmax* – 1).

The pixels can be compared by a simple subtraction operation. The results for all of the pixel coordinates can then be displayed again as an image, as long as we take care to avoid including any results with negative values. In our example, we simply sweep these values under the carpet (more about his later on):

```
intDiff = intGrey1 - intGrey2
if intDiff < 0 then intDiff = 0
```

Figure 3 shows the result of applying this processing to the pair of images shown in **Figure 1** and the greyscale representations shown in **Figure 2**.

Due to ever-present image noise, small changes in overall image brightness and the like, it is unfortunately not possible to distinguish moving objects especially well with this representation, since even the smallest change in the pixel greyscale values is displayed.

We can obtain better results by discarding small changes in greyscale values before generating the output image. For this purpose, we define a threshold *intLimit* (with a reasonable range of 1 to 100). If the difference *intDiff* is larger than *intLimit*, the change in intensity (greyscale level) should be regarded as valid and displayed as a white pixel in the output image. If the change is less than the threshold level or there is no change at all, the pixel remains black.

A new bitmap image can be constructed from the resulting pixels fairly easily in VB.NET by setting the red, green and blue values to 255 where a white pixel should appear in the image:

```
pic.SetPixel(intX, intY, _
Color.FromArgb(intResult, _
intResult, intResult))
```

for all *intX* = 0..*intXmax*-1 and *intY* = 0..*intYmax*-1, with *intResult* being either 255 or 0.

The result of this is shown in **Figure 4**, where the part of the image that has moved can be clearly recognised. However, it may be difficult to associate the result with an object in the original image (not all objects are as easy to identify from their outlines as the author's colleague ;-)). For this reason, we need to combine the data from the original image with the detected pixels to form a new image. The following commands are executed for each pixel. If the pixel is a detected pixel, we set the pixel to medium green, but if no motion has been detected for the pixel, it retains the colour it had in the original image:

```
If intResult = 255 Then
```

```
pic.SetPixel(intX, intY, _
Color.FromArgb(0, 150, 0))
Else
pic.SetPixel(intX, intY, _
Color.FromArgb(intR, intG, intB))
End If
```

The result is shown in **Figure 5**. This sort of image could be fed to a head-up display or something similar to create a form of augmented reality (a live video image enhanced with supplementary data).

Motion detection

The results so far are very nice to look at, but we still need to extract machine-readable values if we want to use them to send a signal to an alarm system or the like. For example, we need to have an indication of whether the detected motion is actually 'critical'. It would also be useful to detect the centre of the moving object. Among other things, this would allow us to aim a second camera at the object in order to record a detailed image.

Both of these tasks are relatively easy to implement. A simple estimate of the relevance of the motion can be obtained by just counting the pixels for which *intResult* is 255. If we also sum the *intX* and *intY* coordinates of the detected pixels and then divide the sums by the number of detected pixels, we obtain the centre of mass of the object represented by these coordinates, as shown in **Figure 4**.

In the example program available for download from the Elektor website [2], a separate procedure has been implemented for each of the algorithms mentioned above. This makes the program a good basis for developing your own applications or just playing with the code (source code file: *PicProcedures.vb*).

Installing Visual Studio Express

If you do not already have the Visual Studio Express 2010 development environment (for Visual Basic 2010) installed on your computer, you first need to download it [3].

Click the download file to start the installation program, which downloads additional files (Internet connection required). After completion of the installation process, you should find *Microsoft Visual Studio 2010 Express* in the *All Programs* list, with the Basic-language version of the development environment under the main entry.

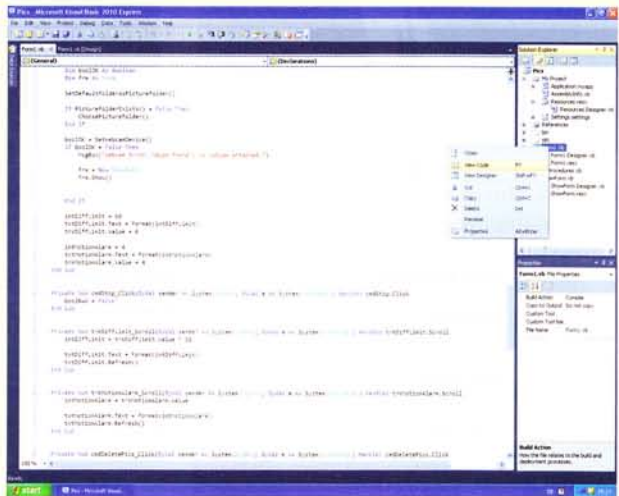

As usual, the example software for this article can be downloaded free of charge from the Elektor website [3]. You should copy the contents of the Zip file to the folder provided by VS 2010 for project files, which is usually *C:\... \User_name\My Documents\Visual Studio 2010\Projects*.

After launching the development environment, click *Project* in the *File* menu and then select the *Pics* project. All files belonging to the project are shown in the *Solution Explorer* window at the top right (projects are called 'solutions' in Visual Studio jargon).

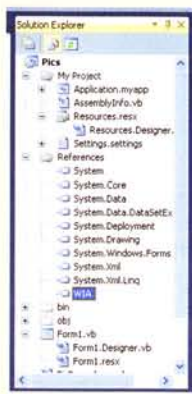

Double-click *Form.vb* to open the main form of the example software in the design view (see **Figure 7**). Here you can edit the controls, such as buttons and text boxes. If you wish to add new controls, select *View >> Other Windows >> Toolbox* to open the toolbox.

Right-click *Form.vb* in the *Solution Explorer* window to display the corresponding code, which defines how the form responds to events such as button clicks. The actual image processing procedures are contained in a separate code module named *PicProcedures.vb*.

Unfortunately, there is not enough room here to describe how to perform tasks such as placing new buttons on the form and linking them to corresponding code, but a free online tutorial on Visual Studio and Visual Basic .NET is available from Microsoft. If you want to work more extensively with this very powerful and entirely free PC development environment, it would certainly be worthwhile to buy a book on Visual Basic 2010. Several books are available at prices ranging from 30 to 50 pounds/euros. Before purchasing one of these books, you should check whether the learning curve demanded by the book matches your existing knowledge; the levels of the various books differ considerably.

Before you try out the software by clicking the green arrow (*Debugging*), you should also ensure that *WIAAut.dll* is installed correctly. After opening the *Pics* project in the *Solution Explorer* window, you will see a *References* folder. Click the '+' sign next to the folder icon to see a list of the software libraries used by the program. You should see *WIA* in this list. If the *WIA* icon is marked with an X, Visual Studio cannot access the *WIAAut.dll* file.

Add a webcam ...

All of this is somewhat pointless without a source of live imagery. Fortunately, the .NET framework facilitates access to all sorts of hardware, including webcams. For this purpose the framework comes with a collection of classes that encapsulate hardware accesses via the corresponding Windows library (.dll) files. If you want to use the classes (i.e. the corresponding commands, status variables and so on) in your own software, you only need to give Visual Studio a suitable reference. Unfortunately, many of these classes are not especially well documented. In the course of a long Saturday afternoon, the author finally discovered which .dll file is the most suitable for this purpose (*WIAAut.dll*) and how to get a webcam to take snapshots under VB.NET so they can be used in user-developed software. A major advantage of this approach is that it does not require any manufacturer-specific drivers. Once the webcam has been recognised as a USB device, it's all systems go.

After a bit of fiddling around, the author persuaded his Logitech QuickCam S5500 to start producing a continuous stream of snapshots that could be used for live image processing. However, we have to live with a couple of limitations here. Everything is very (very!) slow, probably because the images are stored in webcam memory. Furthermore, this memory eventually becomes full. To clear the memory, you have to click the webcam camera icon under 'My Computer' (in Windows XP) and then click 'Delete pictures on camera' to clear the stored images (see **Figure 6**). After the memory was cleared, the author's webcam achieved a dizzying speed of one frame per second, which would certainly leave something to be desired for security-critical applications. However, all we were interested in at this point was trying a few things out.

... and go live

If we compare each webcam image with its previous image, it's possible to detect motion 'continuously'. However, even with the low resolution of the webcam snapshots it would take far too much time to first calculate the greyscale values of both images and then compare them pixel by pixel, ana-

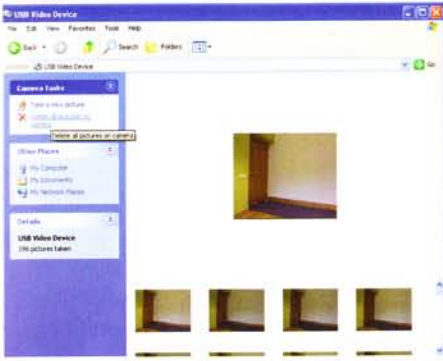

Figure 6. The image memory of the webcam should be cleared from time to time.

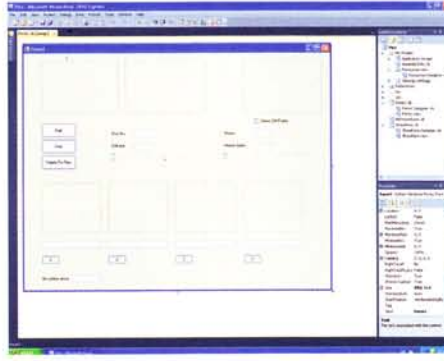

Figure 7. The development environment for Visual Basic 2010 can be downloaded free of charge. Even beginners can quickly achieve useful results.

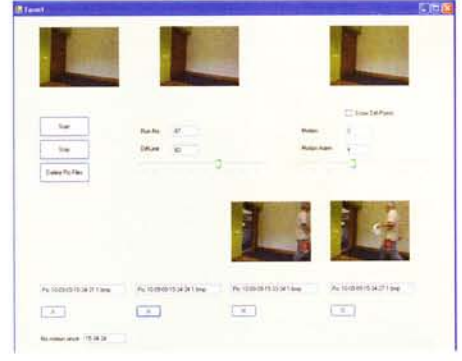

Figure 8. The demo software forms a good basis for DIY projects.

lyse the differential image again, and so on. A significant increase in speed can be achieved by storing the greyscale representation of each image in a sort of buffer, so that it is available for comparison with the next image. As we do not display the actual greyscale images, we can also omit the divi-

sion by 3 and simply sum the red, green and blue components.

The *MotionPicture* function in the example software contains all the code for motion detection. It outputs a bitmap image showing a combination of the original image and

the supplementary motion data melded with the image. This function expects the following inputs: the original image *picNew*, the parameter *intLimit*, and the Boolean variable *boolDrawDiffPoints*, which specifies whether the detected pixels are to be coloured green. The 'relevance' of the

Advertisement

LEDs 1

Elektor Special Project

This special edition offers not only theoretical information but also shows how and where LEDs are applied nowadays. Additionally, this edition contains some tested electronic circuits for DIY.

Theory and applications:

- Control electronics and heat management for LED lighting
- LED projector technology
- Voltage converter with constant-current output for Power LEDs
- LED power and control unit on a single chip

DIY projects:

- Ambilight with Bluetooth
- Budget LED dimmer
- Computerised LED Christmas light
- Programmable LED lamp

And much more!



On sale now!

100 pages • €9.90

Elektor
Regus Brentford
1000 Great West Road
Brentford TW8 9HH
United Kingdom
Tel. +44 20 8261 4509



Further information and ordering at www.elektor.com/shop

AUDIO & VIDEO

Installing WIAAut.dll

WIAAut.dll is not included in all Windows installations. If the WIAAut.dll file is missing in the C:\WINDOWS\system32 folder, it must be downloaded from the Web [4]. After extracting the .dll file from the downloaded Zip file (WIAAut.sdk), drag it to the above-mentioned folder (which also holds the other .dll files).

Next you must register the new library with the operating system. To do this, open the small Windows command line window by clicking Run... in the Start menu (with Windows XP). Enter the command `regsvr32 wiaaut.dll` in the window and click OK.

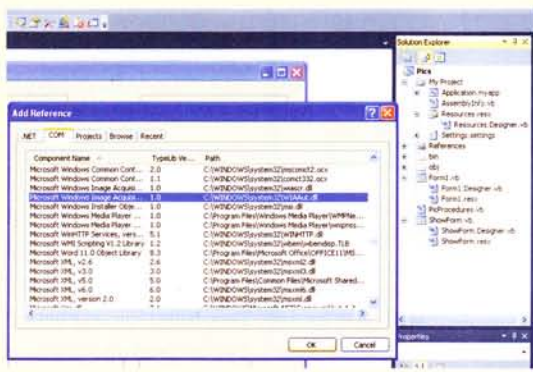

In the window that this opens up, select the COM tab and then select Microsoft Windows Image Acquisition Library v2.0 in the long list. A valid reference should then appear in the Solution Explorer window.

After this you must re-configure the corresponding reference in Visual Studio. You can view all the references in the Solution Explorer window after you open the Pics project (see the 'Installing Visual Studio' inset). If WIA is marked with an X, you must first delete the reference (by right-clicking References and click Add Reference in the pop-up menu. In the

described here: it only works with dark objects moving in front of a light background, and furthermore, in case of objects with different colours the system primary detects the motion of their dark-coloured portions (see Figure 3). This is a consequence of the fact that we discard negative changes in the greyscale values, as previously mentioned. If you wish, you can try using the magnitude of the greyscale difference instead of the signed value. With the latter approach, both bright and dark objects will be detected. However, if the moving object is already visible in the first image, it will appear twice in the output image: once in its original location, and again in its new location. This is because the greyscale values of the pixels change at both locations.

The described experimental scheme is reasonably well suited to checking for the presence of an object, or for similar non-critical monitoring tasks. If you wish to use this motion detection scheme in a security context, increasing the frame rate is essential. It should be at least 5 frames per second (10 would be better) for use in practical situations, so that fast motions can also be detected reliably. Unfortunately, due to lack of time the author was not able to try out other image sources, such as a TV card or the like. We would certainly appreciate reader feedback in this regard.

(100539-I)

Internet Links

- [1] www.elektor.com/090334
- [2] www.elektor.com/100539
- [3] www.microsoft.com/express/Downloads/
- [4] www.microsoft.com/downloads/details.aspx?familyid=a332a77a-01b8-4de6-91c2-b7ea32537e29&displaylang=en

motion is returned to the calling routine in the *intMotion* parameter. The value of this parameter corresponds to the square root of the number of detected pixels. *MotionPicture* also loads the image into a greyscale buffer for the subsequent image comparison. This buffer is empty when the function is first called, so it must be initialised with the data of the first image before the first image comparison (this is handled by the subroutine *InitGreyBuffer*).

Demo program

The author has written a small sample program to demonstrate everything described in this article. Although the user interface isn't likely to win any design prizes, it is fully adequate for initial experiments. This software is solely intended to form a starting point for developing your own applications. Users can also change the values of constants in the source code (see the code for this). For this reason, the author has not generated an .exe file; the software must always be run inside the development environment. The installation process for Visual Basic Studio 2010 is describe in an inset, while linking in the webcam library is described in another inset. After you open the example project in Visual Studio (see Figure 7), click the green

arrow on the toolbar to run the program. The main form (Figure 8) appears after you select the webcam. After you click Start, the webcam starts taking snapshots. The current and previous images are shown at the top left, and the result of the motion detection process is shown at the top right. The left slider adjusts the value of *intLimit*, while the right slider sets the value of *intMotion*, which is the threshold level for triggering an alarm (see above). When this happens, the corresponding image is shown below the slider and saved as a file. The 'X' buttons are provided to delete the displayed 'false alarm' images.

False alarms occur regularly when the automatic brightness control of the webcam causes the entire image to become brighter or darker. To partially filter out this effect, the *MotionPicture* function includes an algorithm that detects global intensity changes. In addition, you should always avoid allowing too much daylight to enter the room under observation, since outdoor lighting conditions are almost always constantly changing.

If you play with this program for a while, you will quickly discover a significant shortcoming of the motion detection scheme

The Definitive UK Event for Electronic Design Innovation and System Design & Development.

Earls Court, London
Conference: 19-21 October, 2010 • Expo: 20-21 October, 2010

Embedded Live features:

- Technical Conference taught by world-renowned experts
- Free Sponsored Technical Sessions presented by industry heavyweights
- ARM Connected Community
- Connected M2M Pavilion

Embedded Live brings together systems architects, design engineers, suppliers and analysts from across the UK. With cutting edge product demonstrations and essential training classes, Embedded Live is the ideal conference for the UK embedded design community to learn, collaborate and recognize excellence.

Start your own personal development at Embedded Live. You can't afford to miss it.

Register Today. <http://embedded-live.com>

EE Times Group

Electronics Weekly

EmbeddedLIVE
<http://embedded-live.com>

Designing and Making Basic Antennas

based on dipoles and monopoles

By Jean Marie Floc'h (France)

The antennas presented in this article were designed for a frequency of 2.45 GHz. This frequency is within the 2.4 GHz ISM band (Industrial, Scientific, and Medical) that can be used without a licence in many countries in the world.

Some simple rules explained below make it easy to design antennas for other frequencies.

The prototypes were made from (adhe-

sive) copper laminate to make them easier to adjust to the correct frequencies (using a craft knife). But we recommend you to make the final versions of these anten-

nas on double-sided PCB laminate, so they will stand up to the weather better. Unless otherwise stated all antennas have a foot impedance of 50 ohms.

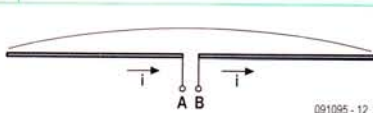
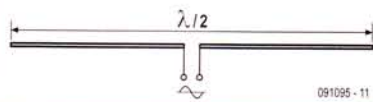

73 Ω, and it radiates omnidirectionally, except in line with the elements, where the radiation is zero. The theoretical gain of the dipole is 2.15 dBi. The term dBi denotes decibels with respect to an isotropic antenna radiating uniformly in all directions and which has absolute unity gain.

Simple dipole

The dipole is one of the simplest antenna you can make. The simple dipole comes in the form of a $\lambda/2$ -long metal conductor divided in two. It is fed from the centre. The currents in the two elements must be in opposite phase, so that the current is maximum at the centre of the dipole. Feeding a dipole requires the use of a balun (for **balanced-unbalanced**) device to produce currents in antiphase and in order to present it with the correct impedance.

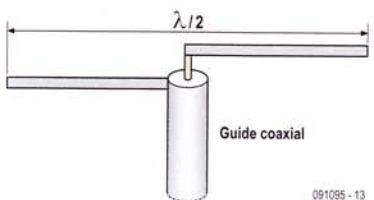
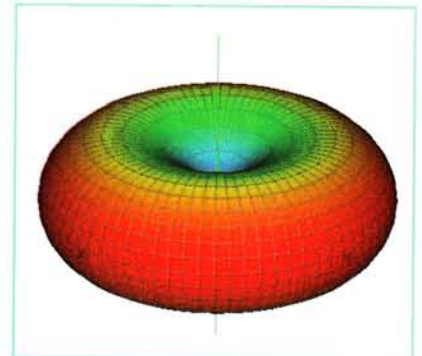

Coaxial dipole

One trick for avoiding the balun and the impedance transformer is to feed the dipole directly via a coaxial feeder. In practice, the physical length of the dipole is slightly shorter (a few percent) than the electrical length.

One of the elements is soldered directly to the centre core of the coax, the other to the ground. The length here is set at 56 mm (two 27 mm elements with a 2 mm gap) so as to obtain a resonant frequency close to 2.45 GHz. At this frequency, the half-wave length is 60 mm. It's best to start with elements that are a little bit longer (making sure that both elements stay the same length), so as to be able to then adjust them to get the resonant frequency required. Bandwidth is around 400 MHz, i.e. 16% of the band's centre frequency. A maximum gain of the order of 2 dBi has been measured. The red curve shows the radiation pattern in line with the dipole (referred to as the E plane, note the humps); the radiation in the plane at 90°, referred to as the H plane, (green curve) is virtually omnidirectional.

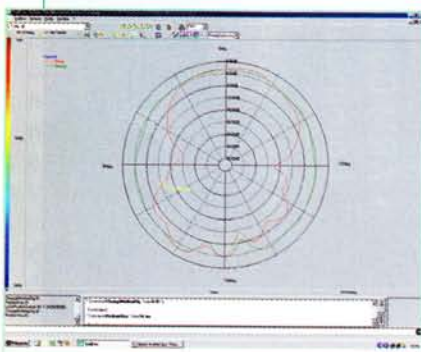

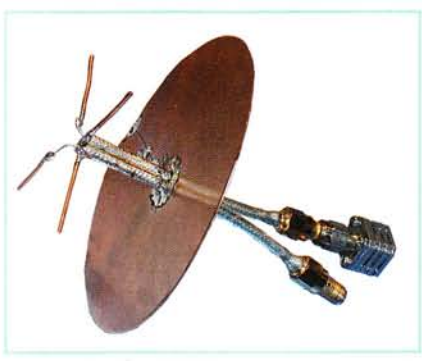

Dual dipole with ground plane

You can try to reduce the backwards radiation from the coaxial dipole by placing a metal ground plane approximately $\lambda/4$ away. To be effective, the diameter of this ground plane must be at least 0.75λ . To keep the radiation pattern symmetrical, it's best to use a disc. Watch out, a slight shift in the resonant frequency is often noticed, so it's necessary to re-trim the lengths of the dipoles. If you want a cross-polarized (H/V) antenna, you can use two coaxial dipoles together.

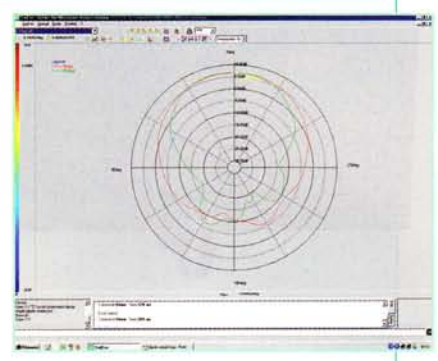

Bandwidth is around 450 MHz (18%). The dual resonance is due to the effect of mutual coupling between the two dipoles. It's best to terminate the unused feed with a 50Ω resistor to avoid spurious effects.

Measurements on the antenna reveal the hole in the radiation in line with the dipole (green curve) and the reduction in backwards radiation (around -15 dB). You can also see greater directivity in both planes, due to the presence of the second dipole in the plane perpendicular to the first one. This results in a significant gain value of 6 dBi. The same results are noted for the other feed point.



Monopole

If you want to reduce antenna size, one simple way is to make use of the electrical images generated by a ground plane. In this way, you obtain a monopole whose size is $\lambda/4$, i.e. half the size. The ground plane also reduces the backwards radiation.

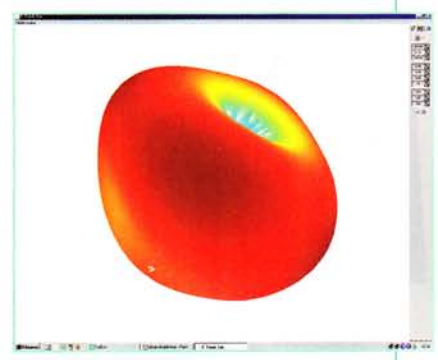

The monopole shown here is fed via a micro stripline (1.5 mm wide) produced on FR-4 PCB laminate. The monopole's 30 mm long element is soldered directly to the line. This is a very simple technique for producing antennas directly on PCBs. You get a bandwidth of around 450 MHz (18%).

A hole is seen in the radiation on the axis of the monopole, and omnidirectional radiation in the perpendicular plane. A slight reduction in the rear radiation due to the presence of the ground plane can be seen. The gain is of the order of 1 dBi.

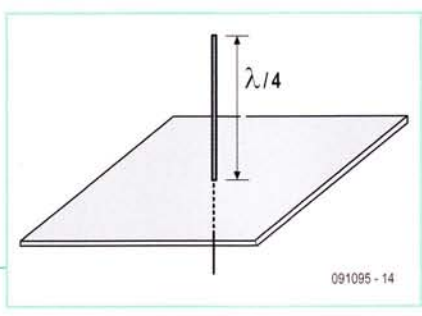

091095 - 14

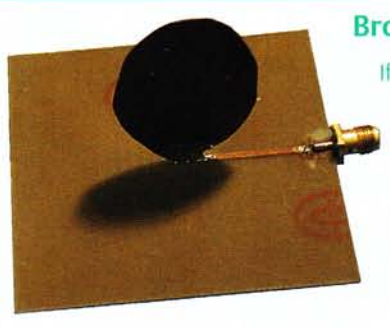

Broadband monopole

If you want to achieve greater bandwidths, you need to adapt the shape of the monopole. Thus you can use an ellipse (see photo). The dimensions of this ellipse — made from 0.3 mm thick copper sheet — are 45 mm high by 30 mm wide. The height of the ellipse corresponds to the antenna resonance centre frequency (here, 1.86 GHz) and is around $\lambda/4$.

The bandwidth is 550 MHz (30%), twice that of dipoles and simple monopoles. The radiation pattern looks the same as that of the simple monopole and the gain too has a value of the same order.

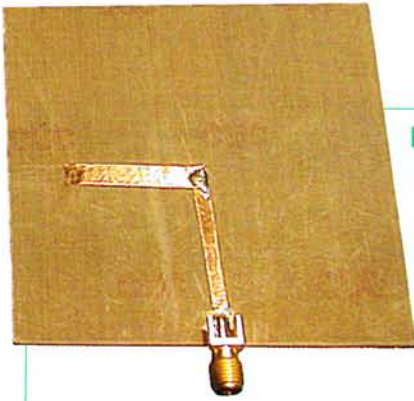

Printed dipole

The two elements of the dipole are now printed each on one side of the substrate. They are fed via a 2-wire feeder, to which an SMA connector is soldered (the centre pin to one element and bulkhead to ground). The antenna proper was made from copper foil, so as to make it easier to adjust the dimensions. But once you've got the dimensions right, we recommend you to make the antennas on double-sided copper-clad board, to improve performance (particularly gain) and get an antenna that will last.

The length of the dipole elements and the distance between the elements and ground is $\lambda/4$. The board used is 0.8 mm thick and has low permittivity (2.2), resulting in slightly higher gain (of the order of 2.4 dBi) and improved bandwidth (of the order of 470 MHz, i.e. 19%).

The disruption in the radiation pattern beneath the dipole is due to the measuring system and the presence of the feeder and connector.

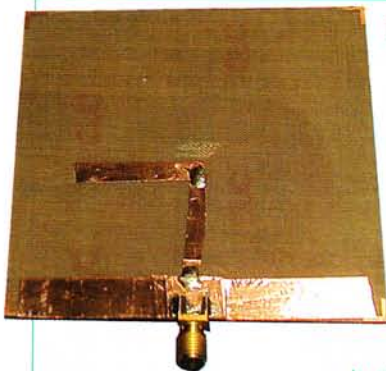
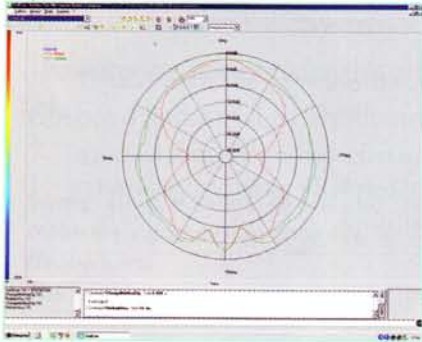
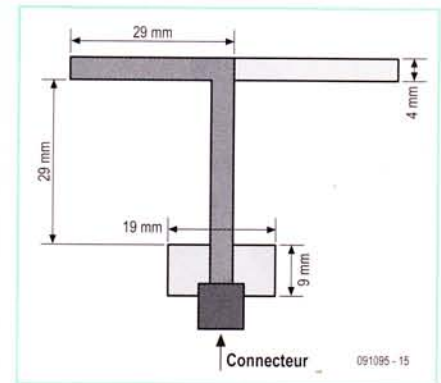

Printed dipole with reflector

If you want to radiate in a half-space and limit backwards radiation, one widely-used technique is to place a reflector soldered to the ground side of the feeder line. The size will be chosen to be slightly larger than the two elements of the dipole. For good matching, the dimensions change slightly compared to the simple dipole. This antenna has a bandwidth of 350 MHz (14%), i.e. narrower than the simple printed dipole.

With this antenna, you can look forward to a reduction in backwards radiation of over 10 dB. The maximum gain is 5 dBi. Also note the radiation 'hole' in line with the dipole elements.

If you want to increase the antenna's gain, simply place a director in front of the dipole elements, at a distance of around $\lambda/4$. This director is markedly shorter than the two dipole elements. In this way, the gain increases by 1.5 dBi. There is a reduction in rear radiation and an increase in directivity (narrower forward angle in the E and H planes).

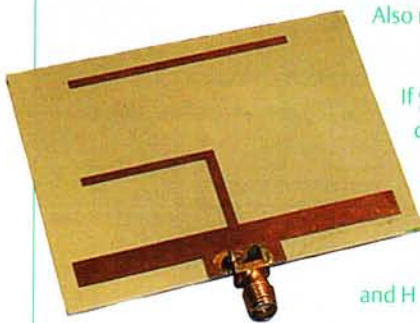
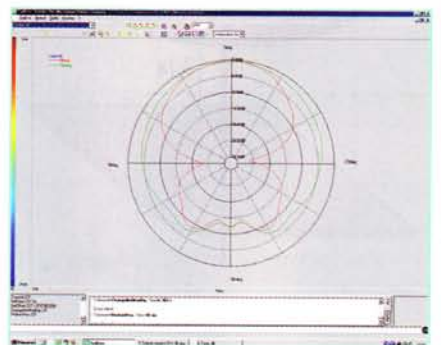
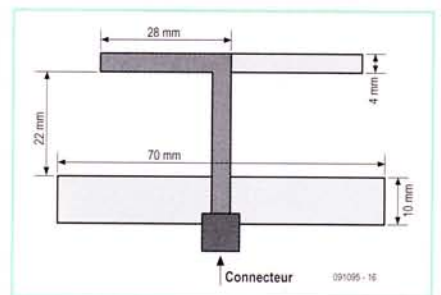

Electromagnetically-coupled printed dipole

In this type of configuration, the dipole is positioned above a micro stripline by the use of a substrate. In this way, you get a dual-layer structure with a feed layer and a radiating layer with the dipole. The energy is coupled to the dipole by proximity or by a capacitive effect. Two configurations are possible:

● **Longitudinal coupling:** the substrate used is FR-4 PCB laminate, 0.8 mm thick for the feeder line and 1.6 mm for the dipole. The dipole measures 9×30 mm (a half wavelength). The feeder line is 1.5 mm wide, in order to obtain a characteristic impedance of 50Ω .

The position of the dipole is adjusted by hand to obtain good coupling and hence good matching of the antenna. To avoid air bubbles and

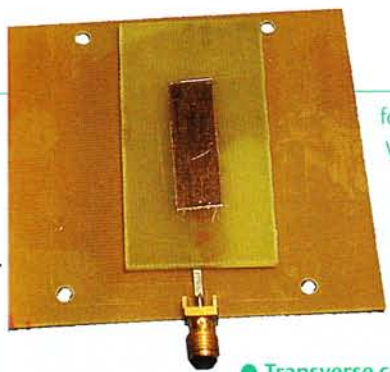

for better reproducibility, it's advisable to put some Vaseline® between the two substrates.

The bandwidth of 55 MHz (2%) is narrower than for a simple dipole. The measured gain is around 1 dBi. This low value is explained by the use of FR-4 laminate, which exhibits significant losses.

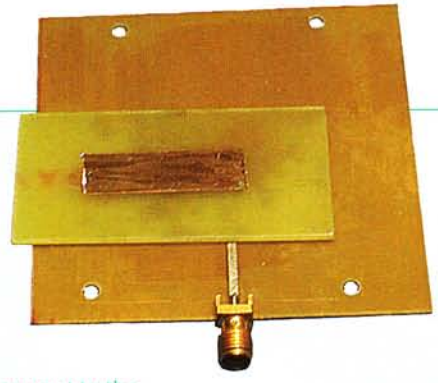

● **Transverse coupling:** this time, the dipole is positioned laterally with respect to the feeder line. The dimensions of the dipole and the characteristics of the substrates are identical with the previous antenna. The dipole position is adjusted in the same way to obtain good coupling between the line and the dipole. The bandwidth is of the order of 40 MHz (1.5%), i.e. slightly narrower than the longitudinally-coupled antenna. The measured gain is around 1.5 dBi.

Patch fed by a micro stripline

Numerous possible patch structures exist for producing antennas. Here, we're going to confine ourselves to just the following two types:

● **Fed by micro stripline** the patch is a 30 mm x 30 mm square on standard FR-4 PCB (thickness 1.6 mm, permittivity $\epsilon_r = 4.3 @ 2.45 \text{ GHz}$, $\lambda = c/(f\sqrt{\epsilon_r})$). The patch feeder is a 1.5 mm wide micro stripline, with a characteristic impedance of 50 Ω . Matching to the patch is achieved using a 9 mm long stub (short section of micro stripline connected at one end only, thus presenting a purely reactive impedance), positioned 20 mm from the patch. This matching can also be achieved using a quarter-wave transformer. Bandwidth is around 55 MHz, i.e. a little over 2%. The measured gain is of the order of 0.5 dBi.

Advertisement

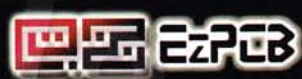

We add value to PCBs when others just sell it.



Designing Service

3D Enclosure Designing Virtual Assembly PCB Design

- One Stop Manufacturing Service
- \$10 ea. for 5pcs 4"x4" 2L
- Free Solder Mask & Silkscreen



- Free Components



- Free Assembly

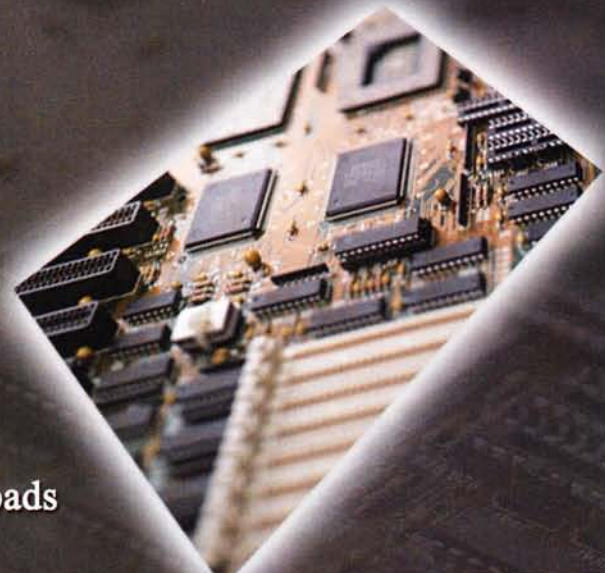

Assembly Components Pcb's
Enclosures Fpcs Keypads

www.EzPCB.com

Email: sales@ezpcb.com

Please Visit www.machinepier.com For Machining

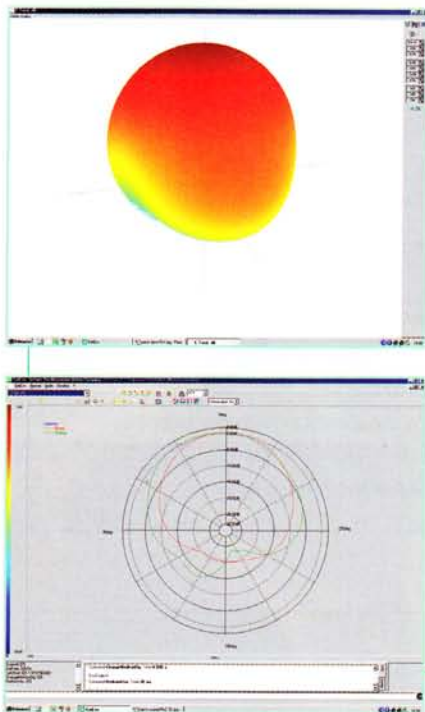

● **Coax fed:** the dimensions of the patch are also 30×30 mm. Coax feed is achieved using an SMA connector soldered to the ground plane on the other side of the board, with the centre core to the patch. Feeding in this way makes it possible to reduce the losses in the substrate. Experience shows that the patch should be fed at a point centred $1/3$ of the way in from the edge of the patch (10 mm in our case). The measured gain is of the order of 4 dBi.

If you want circular polarization, you need to make a notch of about 10% (here 3 mm) at 45° in the two opposite corners of the patch. Depending on the position of the slots with respect to the feed point, you will get either right- or left-hand (RH/LH) polarisation.

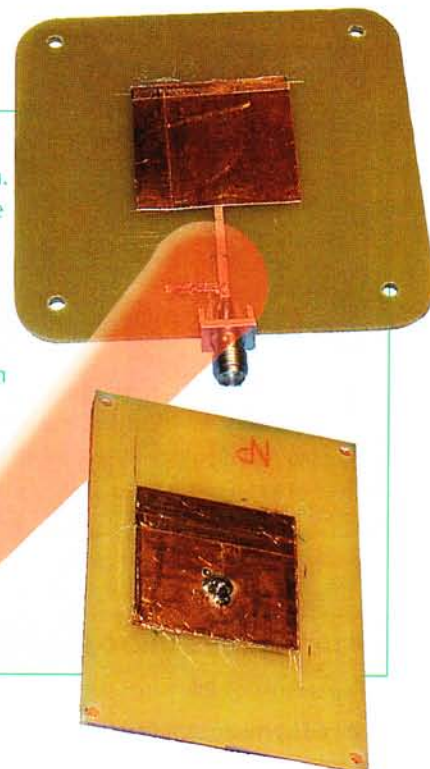

Achieving matching using the Smith chart

In order to achieve matching, you first measure the impedance of the patch at resonance using a network analyser (on the edge of the patch). The impedance for the prototype was 125Ω , purely real at the resonant frequency. You then use a Smith chart to carry out the matching:

- the patch's impedance normalised to 50Ω is $125/50 = 2.5$, i.e. a normalised admittance of $y = 1/2.5 = 0.4$. The constant-reflection coefficient circle (with the point $r = 1$ as its centre) intersects the circle $r = 1$ at $1 + 0.95j$ and $1 - 0.95j$. You accept the solution $1 \pm 0.95j$.

- When the antenna is matched, you are at the centre of the chart at point 1. Hence the stub needs to contribute an imaginary component of $0.95j$ in order to compensate for the patch's admittance, i.e. $(1 - 0.95j) + 0.95j = 1$

- to get from $y = 0.4$ to $1 \pm 0.95j$, you need to move 0.34λ round the perimeter of the Smith chart in the direction of the generator, which means that the stub will need to be positioned $0.34 \times 60 \text{ mm} = 20.4 \text{ mm}$ from the patch. In the prototype, the stub was positioned at around 20 mm.

- Still on the perimeter of the Smith chart, going from y_{co} (open-circuit admittance) to a value of $0.95j$, you find 0.12λ as the stub length, i.e. $0.12 \times 60 \text{ mm} = 7.2 \text{ mm}$. In order to be able to cut it down to adjust, you'll make it slightly longer. The stub on the prototype was 9 mm long.

Near-field measurement setup

Radiation diagrams illustrating the antennas covered in this article were obtained using a Satimo Stargate 32 near-field measurement setup. This makes it possible to perform measurements between 400 MHz and 6 GHz. The system consists of an arch fitted with detectors that measure in real time a cross-section of the radiation pattern of the antenna under test. The antenna is then rotated in order to obtain a 3D diagram. The measurements made below the antenna need to be interpreted with care, as there are no detectors under the antenna and these values are extrapolated.



(091095)

NURVE NETWORKS LLC

XGAMESTATION

Powered By
Atmel MEGA AVR 644
64K FLASH
4K SRAM

AVR 8-BIT

XGS AVR 8-Bit Main PCB Board.
XGS Gamepad Controller.
325+ Page Printed Manual.
Atmel AVR ISP MKII Programmer.
9V Power Supply & A/V Cable.
PC Serial Port to XGS Converter.
PC DVD-ROM.
1GB Micro SD Card + Adapter.
Bonus: eBooks on Hardware,
Game Console Design, and More!

Visit Youtube Channel:
XGSDEV

THE MOST COMPLETE ATMEL MEGA AVR DEV KIT AVAILABLE!

WWW.XGAMESTATION.COM

**www.
elektor.
com**

THE ORIGINAL SINCE 1994

PCB-POOL[®]

Beta LAYOUT

Specialising in Prototype PCBs

NEW! Free Laser Stencil with all Prototype PCB orders

NEW! 1 WD prototype service

NEW! Chemical Tin Finish (no extra cost)

Free Phone
UK 0800 389 8560

@ Simply send your layout files and order ONLINE
PCB-POOL.COM • sales@pcb-pool.com

Beta LAYOUT

Fcell 2009 RS-274-X



Prototypes Multilayer Professional PCBs



Order custom-designed boards from the Elektor PCB Service

The advantages at a glance

- Professional quality PCBs.
- No film charges or start-up charges.
- No minimum order quantity or charge for this service.
- Available to private and commercial customers.
- Design check applied to all entries. We'll let you know within 4 hours!
- Two PCBs supplied – three produced. If the third board is also okay, you receive it as well – free of charge!

Quick, cheap and secure

www.elektorpcbservice.com

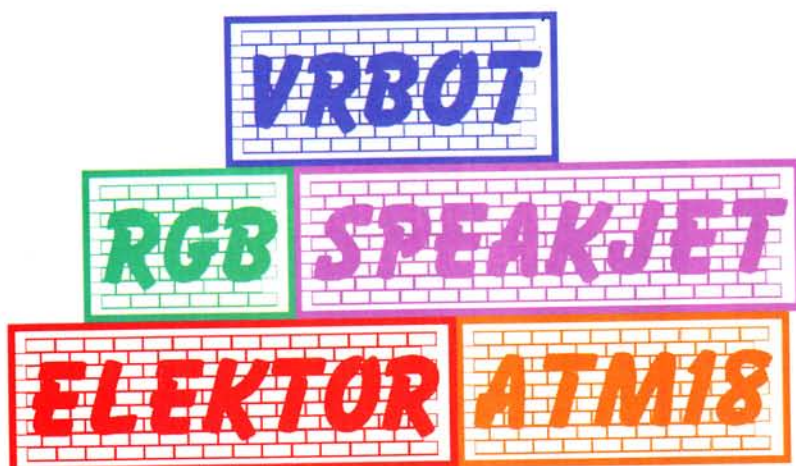

Talk Show

Display what you say

By Grégory Ester (France)

Would you like to equip your project with voice recognition, a voice synthesizer, or maybe a giant RGB pixel? Well, here we're offering you some building-blocks you can put together to suit yourself

Since April 2008, to the delight of many of our readers, the pages of this magazine have been liberally sprinkled with a multitude of applications based on use of the ATM18 AVR board. On the Elektor forum, under the topic heading "Elektor ATM18 // overview of instalments published [1] you'll find convenient links to all instalments in the Elektor / CC2 ATM18 series.

In this article, it's not our aim to enter into the details of a complex implementation of the now world famous ATM18. No! Quite the reverse. For once, let's leave aside the structural and mathematical aspects, and spend a little time looking at how to use 'prefabricated' modules.

These days, the manufacturers' constant efforts to offer us ready-to-use modules mean we can forget the hardware in order to concentrate a bit more on putting these building-blocks together and programming them. It's now easy to create, put together, take apart, and combine functions to produce your latest 'toy'.

Of course, we shouldn't ever lose sight of the fact that electronics leaves no room for chance, and our keyword must be rigorousness. After all, there's no reason why you can't have fun and learn at the same time, is there?

For this particular construction game, I wanted to use voice recognition as well as the reproduction of sound effects and words. To make it a bit more fun, I've added a driver for an RGB module... so "Look, no hands!" Here are the building-blocks (easy to find [3])

we're going to be using:

- **VRbot:** voice recognition module.
- **Speakjet:** a board that can generate voice messages and complex sounds.
- **BlinkM MaxM:** module with three RGB high-brightness 10 mm LEDs designed to be driven via an I²C bus.

The whole project is based on solid foundations: Elektor ATM18, the 2-wire LCD display, and all the software developments that have already appeared and can be downloaded for free (BASCOM-AVR or AVR-GCC) and which can be used as a starting-point to modify or expand as necessary.

What would you say to a third hand?

What do you think of the ability to react to voice commands to replace pressing a button while your two poor little hands are busy holding test probes for precision measurements?

The VRbot voice recognition module can make this dream come true. The recognition is virtually Speaker Dependent (SD), i.e. the timbre of the voice is taken into account in the voice recognition. Say "Open Sesame!" and VRbot will respond to you, and only you! By default, VRbot also offers 25 pre-recorded words in a Speaker Independent (SI) mode.

Table 1. The VRbot vocabulary, divided into seven groups.

Group	Number of words	words
SD1	11	Red, Green, Blue, Mood light, Seasons, Thunderstorm, S.O.S., Black, Hue cycle, Virtual candle, White flash
SD2	6	Left, Right, Up, Down, Forward, Back
SD3	8	Action, Move, Turn, Run, Look, Attack, Stop, Hello
SD4	4	Elektor, VRbot, CC2, Adelek
SI1	8	Action, Move, Turn, Run, Look, Attack, Stop, Hello
SI2	6	Left, Right, Up, Down, Forward, Backward
SI3	11	Zero, One, Two, Three, Four, Five, Six, Seven, Eight, Nine, Ten

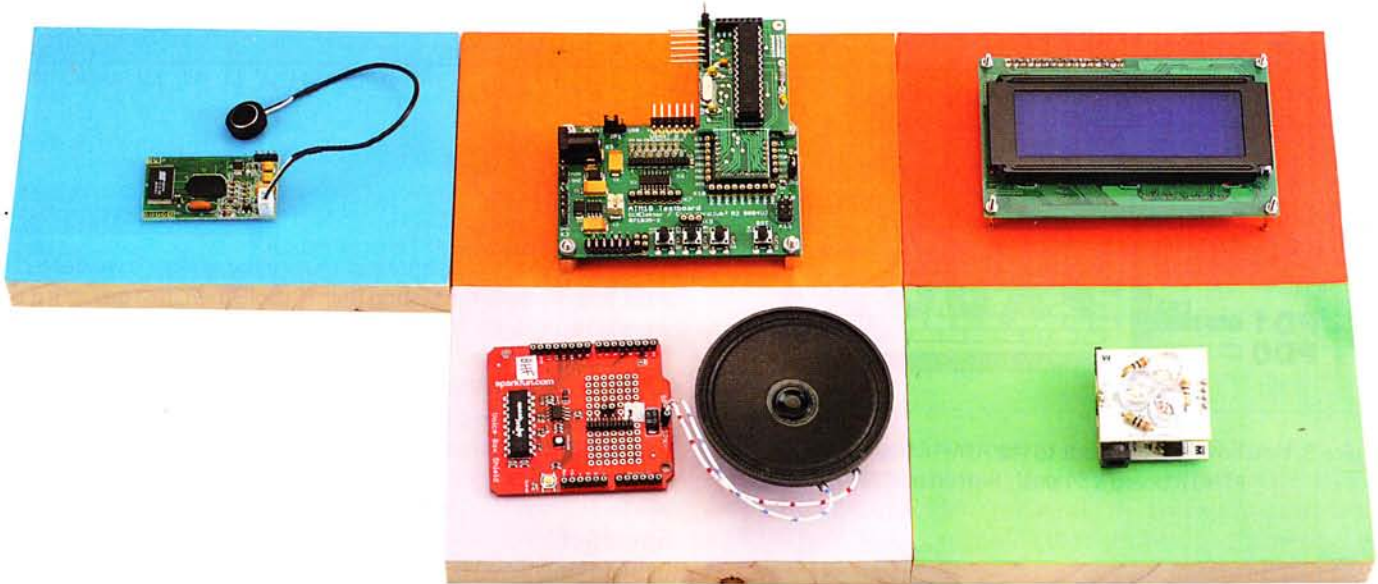

The user stores a collection of words in groups. At start-up, pressing button S1 on the ATM18 board (connected to PB0) allows you to navigate through a menu to choose one of seven groups: SD1 to SD4 (SPEAKJET_VRBOT_TEST_SD.bas) and SI1 to SI3 (SPEAKJET_VRBOT_TEST_SI.bas). The program loops through the selected test to let you test all the words in the group and, where applicable, see the action produced.

You have a few seconds in which to speak. If VRbot understands what you say, it displays the word spoken on the 2-wire LCD display. If it hears noise or if the word is poorly-pronounced or isn't in the memory, it will display "What?!?" If you take too long speaking when you are supposed to, it will display "Too late".

VRbot originally does not speak French, so the author decided to teach it a few words of his native language (SD2 and SD3 in Table 1, English equivalents are shown). In group SD4, it's also taught four new words: Elektor, VRbot, CC2, Adelek. The first group (SD1) contains the names of the mood lights you need to say to drive the RGB module.

Let's take a moment to see how to teach VRbot one of the words in group SD1. To do this, we're going to use the famous USB/5 V TTL serial umbilical cord [4] that will allow us to connect the module to the PC on which you will already have installed VRbot GUI (V1.1.5) [5]. Connect the module to the USB/TTL cable, following the colours as shown in Figure 1, to end up with a cross-wired serial link. Plug the other end into a vacant USB port on your PC.

Start the VRbot GUI software and select the language you want to use to speak the words in the SI group. Select the appropriate COM port and establish the link ('connect'); the software automatically imports words already recorded. A progress bar indicates how the import process is progressing. It's worth noting here that by default, VRbot is configured to operate at 9600 baud.

Now click on the group you want to add words to. Select 'add command' and give it a name, like WHITE_FLASH (for example) for index 10 in group 1 (SD1). Figure 2 shows that the command has been created, but not yet recorded ('Trained: 0'). This is not the moment to be struck dumb with excitement, you're going to

have to speak: soprano or tenor, it doesn't matter! You just need to repeat the same mic word twice with the same intonation at about 40 cm from the mic so that the command can then be recognized

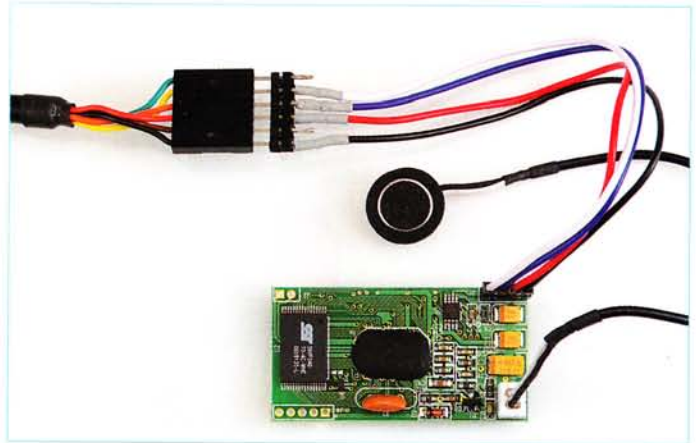

Figure 1. VRbot and the USB link. Don't forget to connect up a microphone.

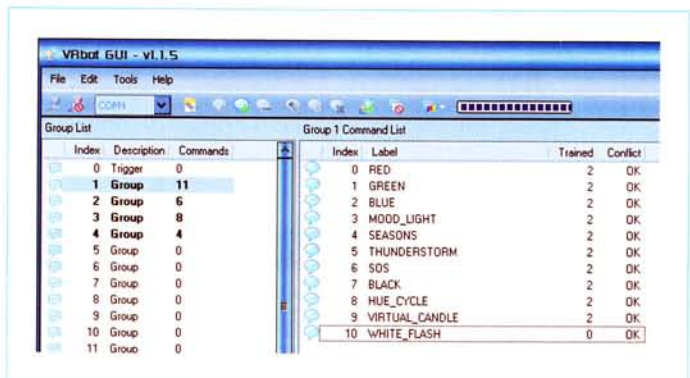

Figure 2. Eleven mood lights. The last one has not been taught ('Trained = 0').

ATM18

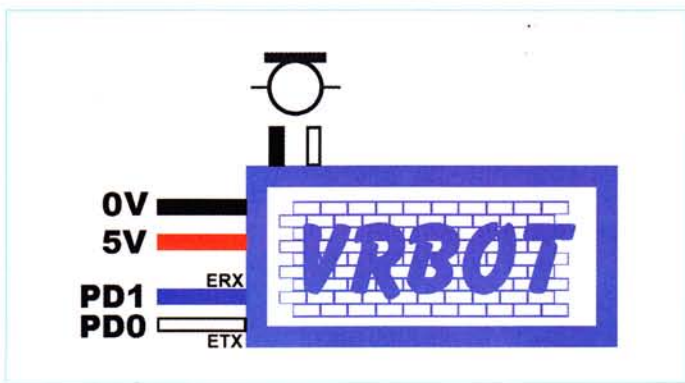

Figure 3. How to connect VRbot to the ATM18 board. Connect the ATM18 board's S1 push-button to P0.

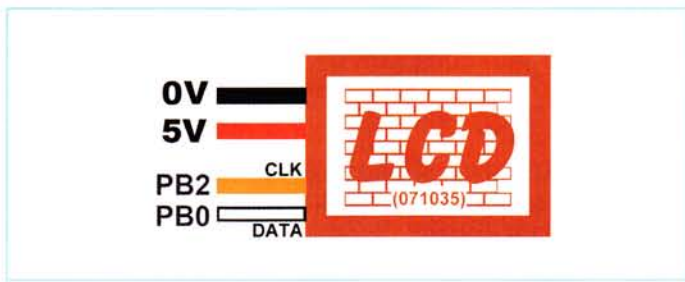

Figure 4. Connecting up the 2-wire LCD display, as described in [2].

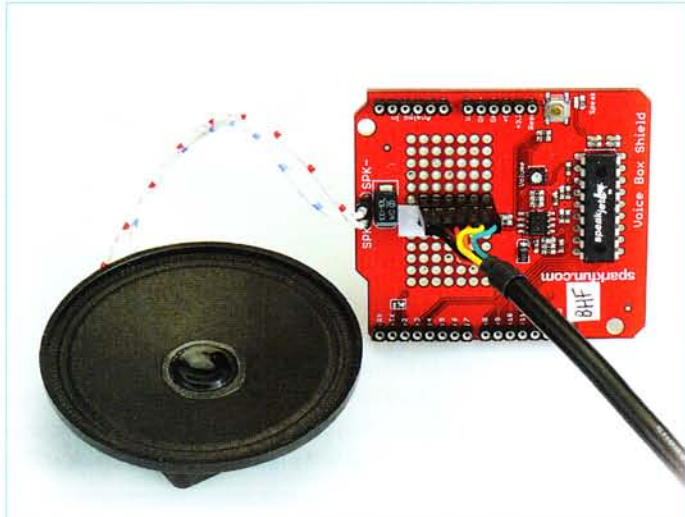

Figure 5. Speakjet and the USB link. This is a one-way connection: this talkative module is too snobby to talk to the computer!

by the system ('train command'). Once the groups have been created, you can have fun testing them ('tool', then 'test group'); if the word is recognized, it is highlighted in flashing green.

At this stage, the VRbot module is ready to be built in to the system. Figure 3 shows the pin-out to follow for connecting to the ATM18 board, Figure 4 shows the same thing for the 2-wire LCD display.

Speakjet...

...uses a 'phoneme'-based voice synthesis technique, just as humans do. Phonemes are the building-blocks that allow us to construct words. An allophone is a possible sound variant of a phoneme. Combined end-to-end, the phonemes form words or phrases. There are 72 sound components available, and using them we're going to be able to form the word 'Elektor'. It's also possible to adjust a multitude of parameters to add tone of voice, a slangy pronunciation, or a question at the end of a sentence, for example. So you need to think of it in terms of the sounds that come out of our mouths, while also allowing for the fact that sounds will be pronounced differently according to their position in the word and the influence of the surrounding vowels. For example, the B in book will not be pronounced the same way as the B in baby.

There are numerous nuances, but the device's technical documentation is very comprehensive and you'll find it essential reading. You'll be able to learn all about the use of diphthongs, silences, stressed and unstressed intonations, and so on.

A bit more fun is the possibility of producing 43 sound effects (alarm, biological noises, etc.) and 12 DTMF frequencies.

So we're going to implement the board based around the Speakjet IC. The Phrase-A-Lator [6] software lets you communicate directly with the module so you can test the words in the built-in dictionary or ones you've made up yourself, along with the sounds. It's also possible to control events according to the state of certain inputs, and to store words in EEPROM memory so that you can then very easily call them up using just a few lines of code. A small area with solder pads will let you very quickly solder an adjacent row of six male pins, which will let you program the board directly, once again using the USB/5 V TTL serial cable. To do this, you need to solder three wires as shown in Figure 5: TxD of the USB/TTL serial cable (pin 4, orange) to the 'pin 2' on the Speakjet board that's next to the 'TX'

Table 2. Here's how a few other words can be formed.	
And	\SLOW \AY \SLOW \NE \OD
ATM18	\EYIY \IY \TU \IY \IY \EH \EH \MM \NTF#2 \EYIY \P4 \TT \IY \NE
Present	\PO \FAST \RR \EY \SE \EH \NE \TT
Speakjet	\SE \PE \SLOW \IY \EK \JH \EH \TT
VRbot	\SLOW \VV \SLOW \IY \P6 \P6 \AWRR \P6 \P6 \BO \OH \TT

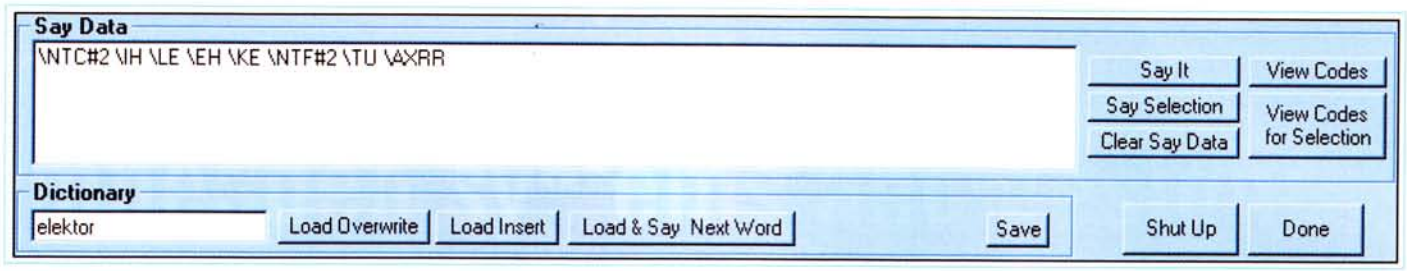

Figure 6. Make it say what you want it to.

pin; the +5 V rail (pin 3, red) and ground (pin 1, black) for powering the board will be derived from the USB port via the same connector. After installing the Phrase-A-Lator software, connect the whole thing to a vacant USB port on your PC. You should then hear a robotic voice say "ready", telling you that everything is in order. Run the software, select the COM port and click 'Test serial connection'; you should hear another "ready" to indicate the link is working. Now click on Phrase-A-Lator and compose the word 'Elektor', with the help of Figure 6. Click on the 'say it?' button, and hey presto! it's said it.

Table 2 shows how to construct the other words of the welcome message "Elektor and ATM18 present Speakjet and VRbot" which will be heard when the Talk Show is powered up. You'll need to save the words into EEPROM memory so you'll be able to call them later on using a few lines written in BASCOM-AVR. The procedure is simple. Run the Phrase-A-Lator software, then select 'EEPROM editor'. When editing the last word (in this case, 'Elektor'), refer to Figure 7 for the four steps to follow for saving all the words to the EEPROM. You'll need to take care to store all the terms in the correct places in the EEPROM memory. Clicking on 'view codes' will let you generate part of the code

needed to complete the program in BASCOM-AVR (Figure 8). Click the 'save' button to save your composition into the dictionary. Lastly, Figure 9 shows how to connect the Speakjet module to the ATM18 board. Make sure you use the right 'pin 2' — it's the one next to the 'TX' pin.

Mega 1-pixel display

The last building-block we're going to be using (Figure 10) includes three 10 mm high-brightness RGB LEDs. Figure 11 shows how to connect this "mega" pixel to the ATM18 board. The whole thing is designed to be driven via an I²C bus. Additive synthesis is used, and 3 × 8 bits allow the colour mix to be controlled very precisely. And that's not all — there are lots of options for configuring this giant pixel, like the generation of various display sequences in stand-alone mode, the choice of transition speed, random illumination, etc. At start-up, by way of a test, the colour displayed will be Elektor red (217 / 0 / 0 in decimal). Our 'smart pixel' will follow pre-defined scripts. Say one of the eleven mood lights in group SD1 in order to see it appear on the RGB LEDs: 'storm', 'virtual candle', 'seasons', etc. — whatever you feel like.

Summary of Talk Show operation

At start-up, you'll hear 'ready', so Speakjet is ready to speak. The I²C address of the RGB module is detected automatically. The welcome screen comes up and Speakjet speaks the text at the same time. Next it displays the number of words in VRbot's first four SD groups (Table 1).

Pressing S1, accompanied by a pretty tinkling sound, will let you browse a menu where you can select the group to be tested. By default, group SD1 or SI1 is active (depending on the program loaded). Speak when you are prompted to. If you take too long, you'll get the reply "Too late"; if you pronounce the word badly or there is background noise, the reply is "What?!?" If the word spoken is recognized ("Fine!!!"), it is displayed and, where applicable, the event is triggered. As it stands, the mood lights (SD1) are activated and emitted by BlinkM MaxM or the word "Elektor" is spoken (SD4).

Pressing S1 will take you back to the main menu, otherwise the test will loop indefinitely through the selected group.

Note that if a problem arises while the VRbot module is being detected, a superb alarm generated by Speakjet is set off and the message "YOU MUST RESET!!!" is displayed. In this event, press button S4 (RST) on your ATM18 board (µC reset) or wait ten seconds for the program to re-boot of its own accord.

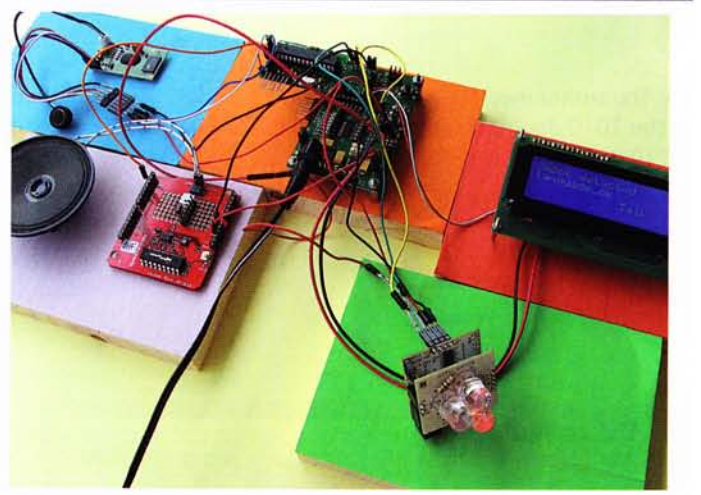

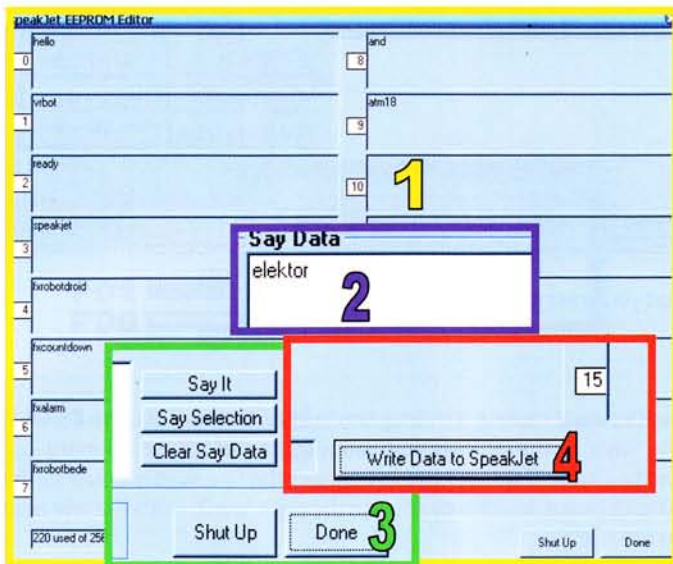

Figure 7. End with “Elektor” so you can then finally save the words in the EEPROM memory (step 4). And have you tried number seven (fxrobotbede)? Does it remind you of anything?

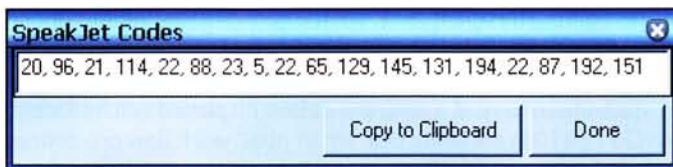

Figure 8. The code generated for the word “Elektor”. The values mean that the volume (20) is set to 96, speed (21) to 114, pitch (22) to 88, bend (23) to 5, then 22 and 65 (sets the frequency to C#2), 129 (\IH), 145 (\LE), 131 (\EH), 194 (\KE), 22 and 87 (sets the frequency to F#2), 192 (\TU), and to end 151 (\AXRR).

P.S. The author used the ATM18-DIP version (090896) as published in the 2010 double issue instead of the ATM18 controller board (071035-91)

(100360)

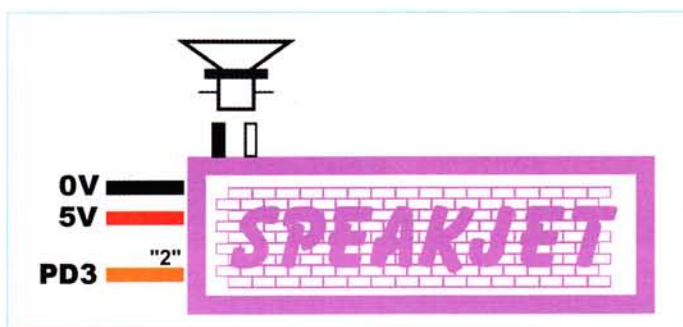

Figure 9. Connecting up the Speakjet. Note that the pin referred to as '2' is the one next to the 'TX' pin.



Figure 10. The mega-pixel BlinkM MaxM display is amazingly powerful, it generates a light source 1000 times brighter than a standard high-brightness LED! So it's vital never to look directly at the light source, at risk of serious eye damage.

Internet links

- [1] www.elektor.com/forum/elektor-forums/recent-main-projects-and-articles/elektor-atm18.1149868.lynkx
- [2] www.elektor.com/071035
- [3] Modules: www.lextronic.fr
- [4] USB / TTL serial cable: www.elektor.com/usb-ttl
- [5] VRbot: www.tigal.com/1770
- [6] Speakjet: [http://www.magnevation.com/Download page](http://www.magnevation.com/Download_page)
- [7] BlinkM MaxM: www.sparkfun.com/commerce/product_info.php?products_id=9000
- [8] Project software: www.elektor.com/100360

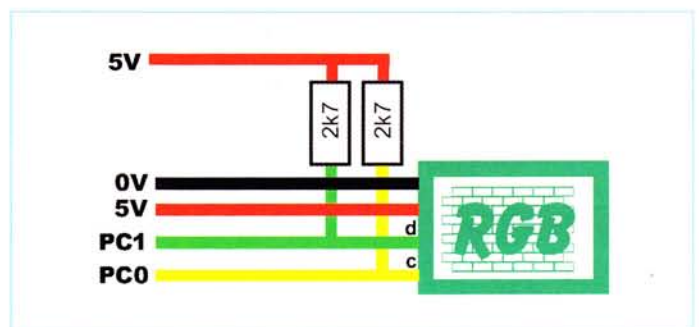

Figure 11. Connecting up the giant pixel.

Subscribe now to the leading US-based computer applications magazine specializing in embedded systems and design!



Select your personal subscription at

www.cc-access.com/subs

12 editions per year for just

Print: \$63

Digital: \$38

Print + Digital: \$90

CIRCUIT CELLAR®

THE MAGAZINE FOR COMPUTER APPLICATIONS

UniLab Duo

2 x 0–30 V 3 A bench PSU

The UniLab bench supply we published in the April 2010 issue of *Elektor* has proved very popular. Here we show how to extend the project into a twin-output supply taking full advantage of the dual voltage/current display published in the September 2010 issue, including wiring plan and front panel design.

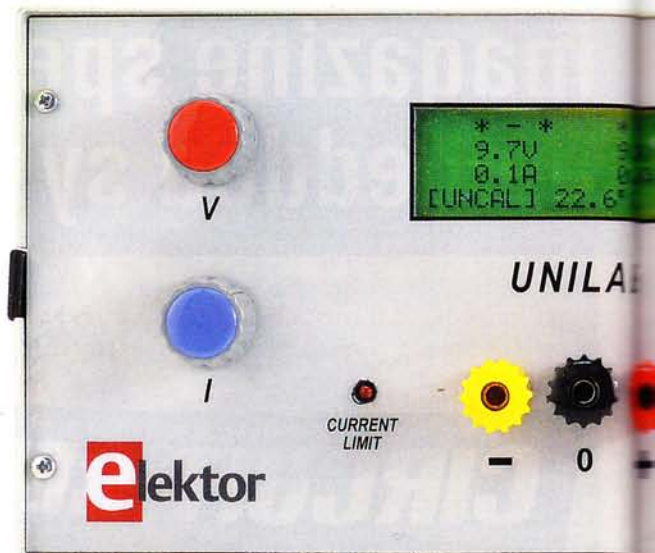

UniLab is a bench power supply based on a switching regulator. Technical details and a circuit description can be found on the *Elektor* website [1]; and you can purchase the printed circuit board (order code 090786-1) from the Elektor Shop, as well as a kit of parts (090786-71) which includes the printed circuit board along with all components apart from the mains transformer. For the twin-output version of the supply we need two populated boards plus the dual voltage/current display circuit. The four-line by twenty-character display shows the two

output voltages and output currents as well as the temperature inside the unit's enclosure. Again, the display circuit is available as a complete kit of parts from the *Elektor* shop (order code 100166-71), including printed circuit board.

Optionally you can add the soft-start circuit from our 1997 Summer Circuits issue ('Mains on delay circuit'), included in the wiring plan in **Figure 1**, which limits the input current on the mains side to avoid those embarrassing moments when you

switch the power supply on and trip the circuit breaker in your consumer unit, plunging the house into darkness. The printed circuit board can be obtained via the project web page [3].

Transformer and enclosure

For the prototype shown here we used a toroidal transformer with two 25 V secondaries rated at 3.2 A. The two 8 V windings for powering the voltage/current display were manually added to the transformer, as described in the original article in Septem-

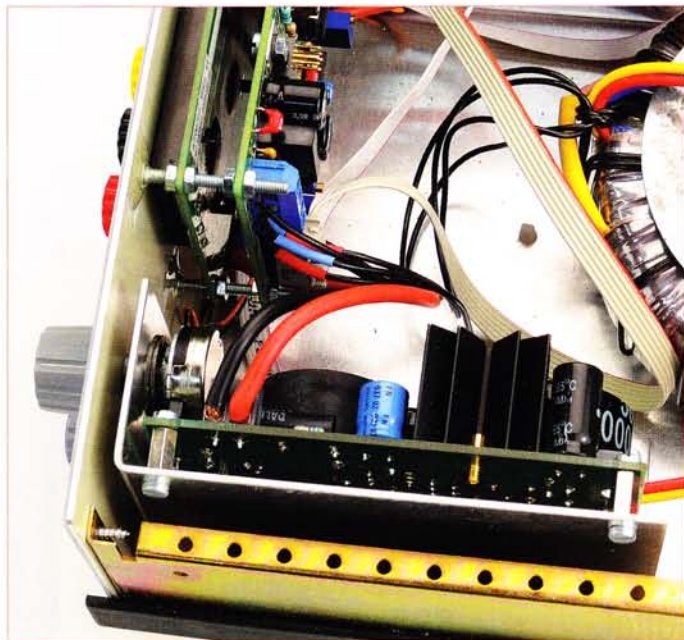
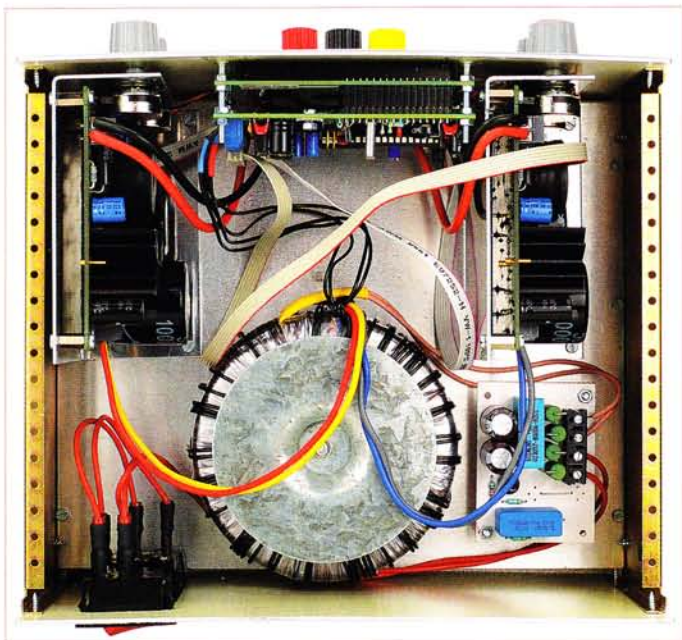

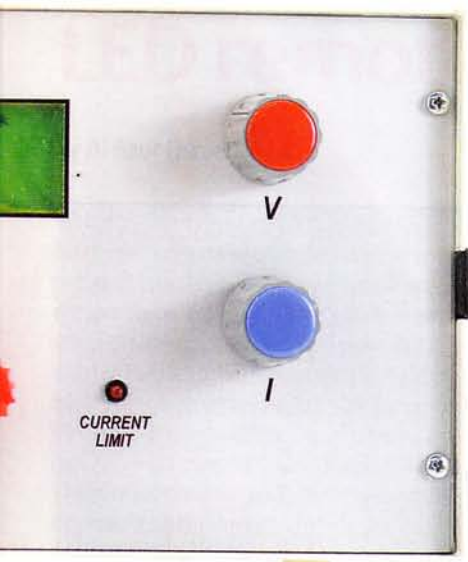

ber 2010. It is of course also possible to use a separate 3.3 VA transformer with two 8 V windings to power the display, assuming it will fit in the enclosure.

The two-part metal enclosure we used is the Telet LC1050, which has been used in *Elektor* projects in the past. Sadly Telet has since disappeared from the market. The case measures 22 cm wide by 25 cm deep by 12 cm high (8.7 x 10 x 4.7 inch). A front panel was designed for use with the enclosure (Figure 2), and the layout is available as a freely downloadable PDF file on the project web page [4]. Various methods for making the front panel overlay were described in an *Elektor* article in November 1997 (article available, see [5]).

It is of course possible to use a different model of enclosure as long as it is large enough to hold all the boards and transformer (or transformers). The dimensions of the front panel will need to be adjusted accordingly.

Construction

The first step is to equip the enclosure with an extra baseplate made from 2 mm (0.08 in.) aluminium sheet, designed to fit the enclosure's side mounting rails. This 'mezzanine floor' simplifies mounting the various parts and avoids modifying the enclosure's bottom panel. Everything apart from the voltage/current display, the current-limit LEDs, the output sockets and the mains inlet is fixed to this plate.

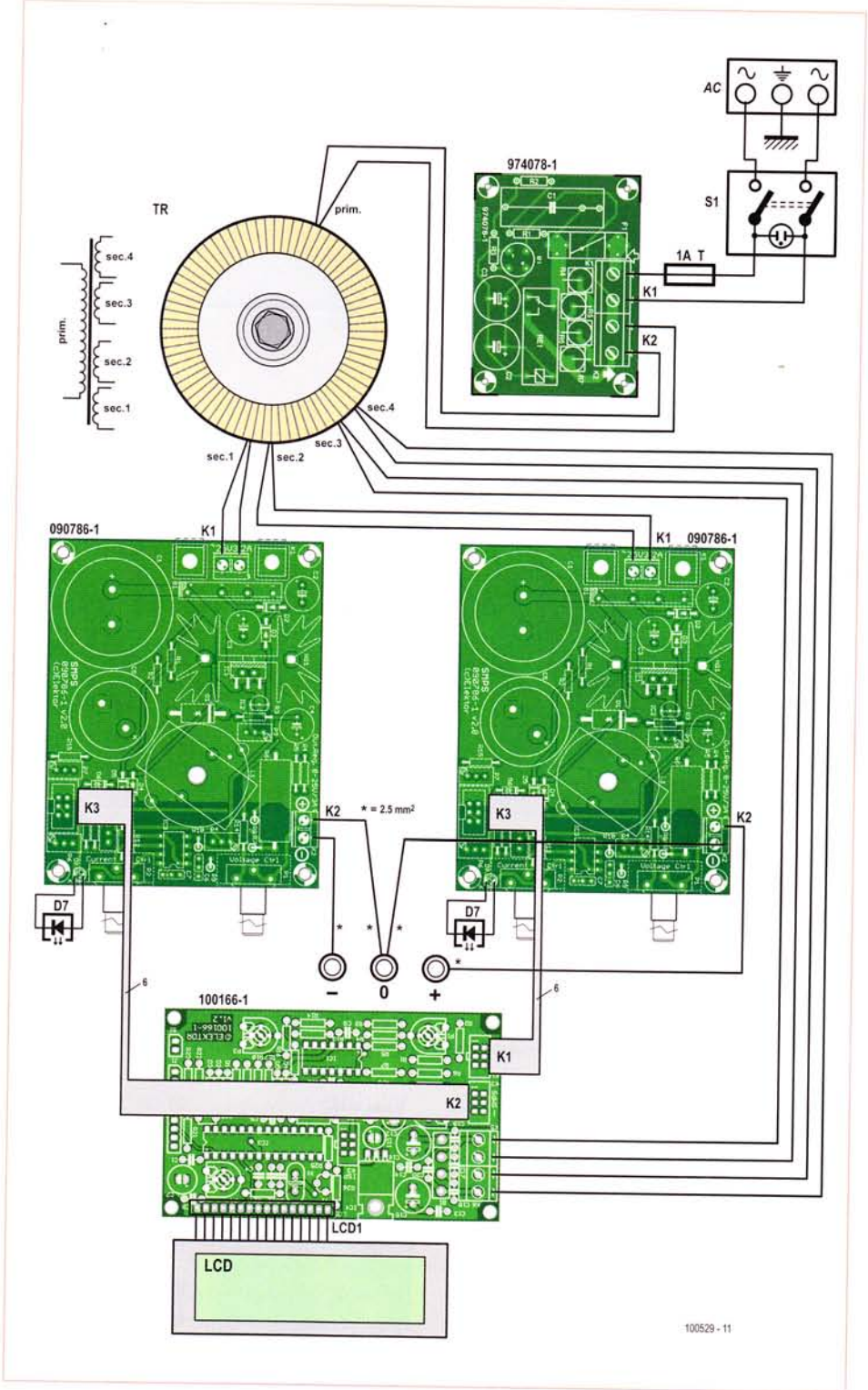

Figure 1. Overall wiring diagram for the twin-output bench supply.

To economise on space the two UniLab boards are mounted vertically. The required mounting brackets can be made from 1.5 mm (0.06 in.) sheet aluminium: mark the fold line and bend the sheet in a vice with the help of a short wooden batten. The dimensions of the brackets are available

as a downloadable PDF along with the front panel drawings [4]. The mounting positions of the two UniLab boards are determined by the position of the holes for the potentiometer spindles in the front panel. In our prototype the potentiometers were bolted to the mounting

POWER SUPPLIES

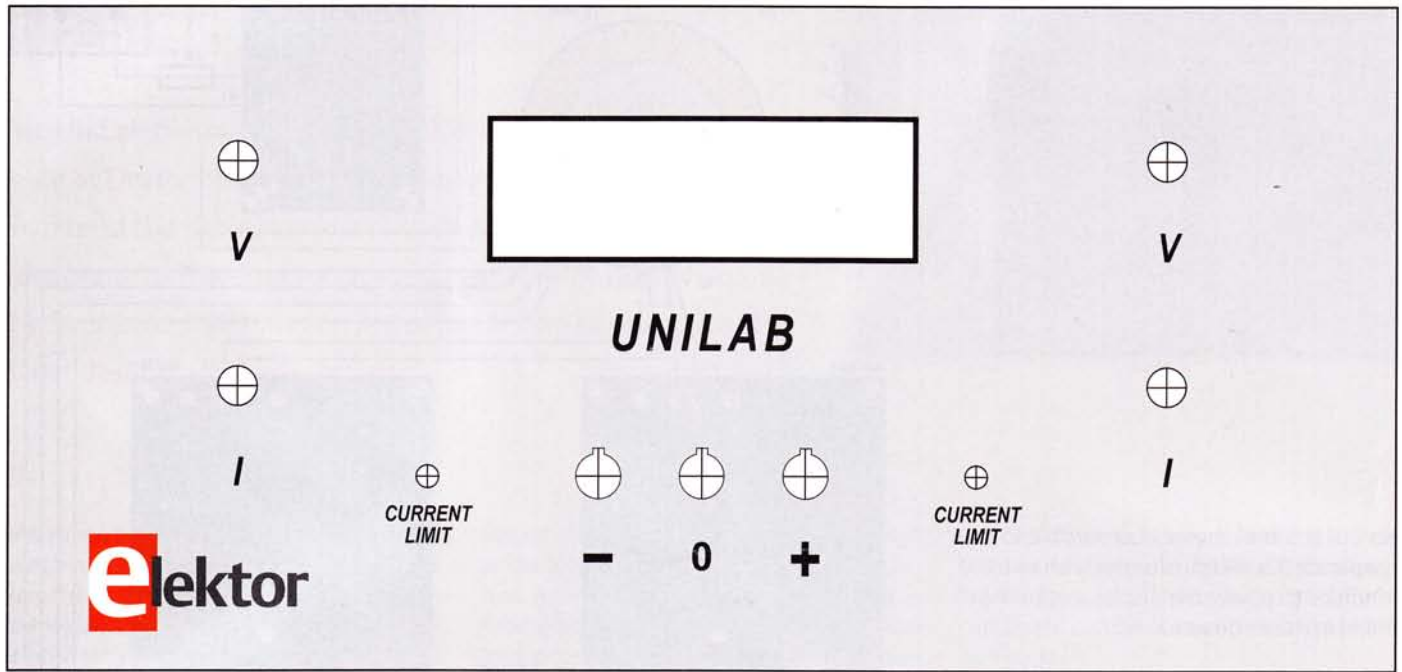

Figure 2. The front panel design can be downloaded free from the *Elektor* website and printed out onto a suitable film.

brackets behind the front panel rather than to the panel itself, but at the same height as the holes in the panel. The bracket and the UniLab boards were then fixed to the baseplate using M3 screws. Take care to ensure that there is enough space for the display board and the three output sockets between the two UniLab boards. If necessary, fit pieces of insulating material to prevent short circuits.

The toroidal transformer is mounted on the baseplate behind the UniLab boards using the M6 screw and nut supplied with it. On the right next to the transformer there is enough space on the rear panel of the enclosure to fit a mains inlet module, incorporating a mains switch and fuseholder. The optional soft-start circuit board can be mounted to the left of the transformer.

The display requires a rectangular cut-out in the aluminium front panel measuring 76 mm by 25 mm (3 x 2 in.). This can be made using a fine-toothed fretsaw, neatening up the results with a warding file. To mount the voltage/current display we fixed M3 bolts to the inside of the front

panel using a two-component adhesive. It is important to key and degrease the relevant areas of the panel before applying the glue.

Wiring

The complete wiring plan is shown in Figure 1. It is important to observe the gauges of the various wires involved: the connections to the output sockets should be made using 2.5 mm² (approx. 13 AWG) wire, while ordinary 0.75 mm² (approx. 18 AWG) insulated stranded hook-up wire can be used for all the other connections.

Exposed metal on all wires carrying mains voltages should be carefully insulated at the AC power inlet module using heatshrink tubing, and of course you must ensure that the chassis is securely connected to AC power-line Earth.

The voltage/current display is simply connected using six-way flat cables and headers.

(100529)

Internet Links

- [1] www.elektor.com/090786 (UniLab bench supply)
- [2] www.elektor.com/100166 (dual voltage/current display)
- [3] 'Mains On Delay Circuit', *Elektor Electronics* July & August 1997 (article on Elektor 1990-1999 DVD)
- [4] www.elektor.com/100529 (front panel artwork)
- [5] 'Make your own Front Panels', *Elektor Electronics* November 1997 (article on Elektor 1990-1999 DVD)

LED remote control for RC models

By Al Baur (Israel)

When flying a remote controlled (RC) airplane in the dark, it helps to have different colored lights on the wings. The use of high-intensity red and blue LEDs on the wings allows a visual takeoff/landing indication to be added to the plane and seen from a distance. When used on helicopters the different color LEDs are sure to stir up UFO stories in the local newspaper within a few days.

Most RC transmitters have a spare channel for a simple on/off function ('SWITCH') transmitting fixed 1 ms or 2 ms pulse lengths; if not, a normal 'stick channel' is also suitable for use with this circuit shown here. The circuit consists of three ICs in essence. Two halves of a CD4538 operate as fixed-length pulse generators triggered by the receiver's output pulses, IC1.A supplying 1.25 ms pulses and IC1.B, 1.75 ms pulses. Two flip-flops in a 4013 package, IC2.A and IC2.B, compare the reference pulses with those obtained from the receiver, which are either 1 ms or 2 ms for an 'on/off' type of channel, or vary in length between 1 ms and 2 ms for a stick channel. Each flipflop toggles its Q and Q outputs depending on the outcome of the length comparison. Using gate IC3.A the circuit decides it's a 1.5 ms pulse if neither 1 ms or 2 ms is detected, thus adding the third digital output.

Unless you are using very low current LEDs (not recommended), the red and blue wing LEDs should be connected through transistor drivers. (081145)

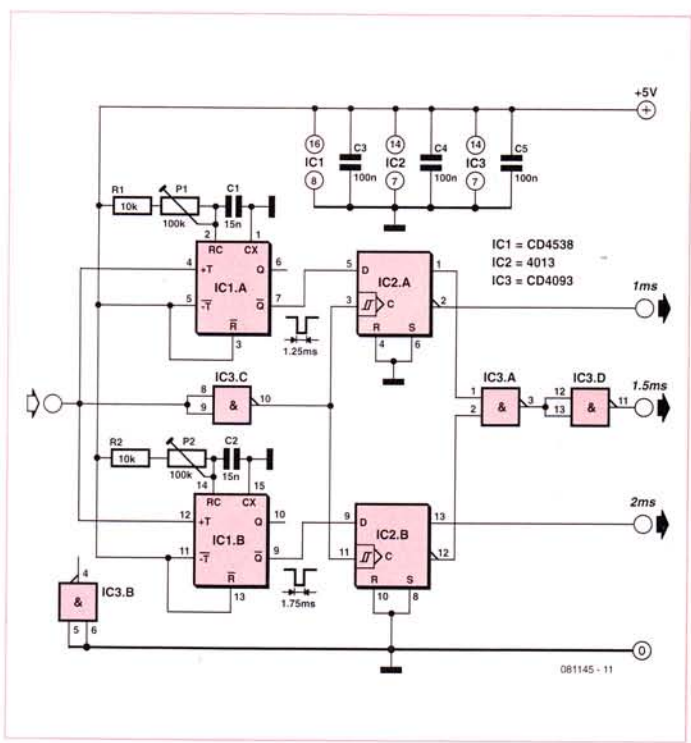

Simple IR remote control tester

By Tom van Steenkiste (The Netherlands)

On the Internet you can find them in all shapes and sizes: circuits to test remote controls. Here we describe a simple and cheap method which is not that well-known.

This method is based on the principle that an LED does not only generate light when you apply a voltage to it, but also works in the opposite direction to generate a voltage when light falls on it. Within constraints it can therefore be used as an alternative for a proper photo transistor or photo diode. The major advantage is that you will usually have an LED around somewhere, which may not be true for a photo diode.

This is also true for IR (infra-red) diodes and this makes them eminently suitable for testing a remote control. You only need to connect a voltmeter to the IR diode and the remote control tester is finished.

Set the multimeter so it measures DC voltage and turn it on. Hold the remote control close to the IR diode and push any

button. If the remote control is working then the voltage shown on the display will quickly rise. When you release the button the voltage will drop again.

However, don't expect a very high voltage from the IR diode! The voltage generated by the diode will only be about 300 mV, but this is sufficient to show whether the remote control is working or not.

There are quite a few other objects that emit IR radiation. So first note the voltage indicated by the voltmeter before pushing any of the buttons on the remote control and use this as a reference value. Also, don't do this test in a well lit room or a room with the sun shining in, because there is the chance that there is too much IR radiation present.

To quickly reduce the diode voltage to zero before doing the next measurement you can short-circuit the pins of the diode briefly. This will not damage the diode.



(090480)

Camera Interval Timer

With infrared remote control



By Jean-Pierre Gauthier (France)

As a passionate orchid-grower, I wanted to photograph these beautiful flowers as they opened, so as to understand and admire their blossoming. I first tried to do it using my camera's remote control, but that wasn't very practical. Taking a closer look at my camera's instructions, I noticed that the shutter and focus commands were accessible via a jack socket. That was just what I needed...

Technical characteristics

- PIC16F886 microcontroller
- Compatible with Sony SIRC remote controls
- Number of photos programmable between 1 and 100
- Interval programmable between 1 and 3,599 s
- Automatic standby
- Optimised for Canon EOS camera, but can be used for any other purpose

The camera shutter operating system described here makes it possible to take photos at a predefined interval, or to trigger two cameras together for stereoscopic shots. This device makes it possible, for example, to take a series of photos every 30 minutes of a flower as it opens, a baby bird hatching, etc. so as to include them in a video. The system was originally designed

for a Canon EOS camera, but it can readily be adapted for other cameras that are able to be remote controlled.

The timer is capable of taking from 1 to 100 photos at intervals from 1 second to 59 minutes, 59 seconds, with or without pre-focusing. The parameters are stored in EEPROM. An alphanumeric LCD uses four lines of 20 characters to show the number of shots taken and display menus to help you configure the device. The backlight is controlled by the microcontroller.

If necessary, you can adjust the focus and shot at any time between shots by using a remote control compatible with Sony's SIRC protocol [3]. Once all the photos have been taken, the timer goes into stand-by mode to save power.

A simple circuit

Thanks to the use of a microcontroller, the circuit itself (Figure 1) has been kept simple: four push-buttons, a liquid crystal display, and a few additional components are all it

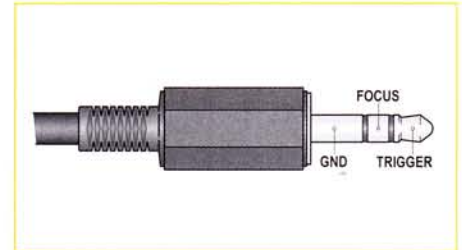

Figure 2. Here's how to wire up the control plug for the Canon camera.

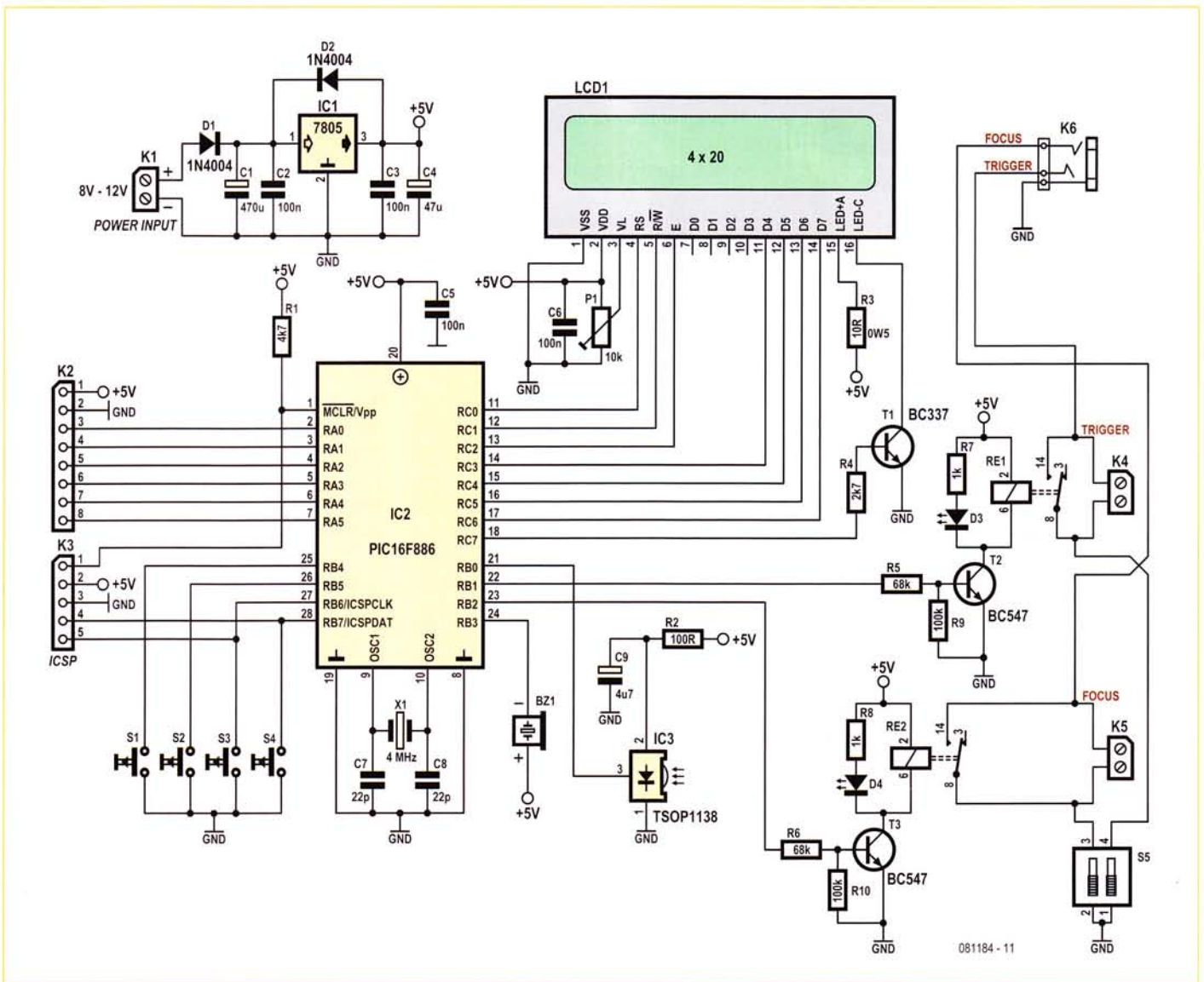

Figure 1. The timer is a basic microcontroller project.



Figure 3. Setting key 1 of the remote.

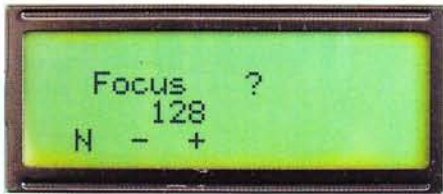

Figure 4. Setting key 2 of the remote.



Figure 5. Setting the number of photos to be taken.



Figure 6. The first menu in 'Normal' mode.



Figure 7. Setting the interval between two shots.



Figure 8. The screen during shooting.

takes to control the camera. The shutter and focus commands are produced using two relays RE1 and RE2, driven by transistors T2 and T3. The two relays connect the contacts of the jack socket K6 to ground via the switches in S5. **Figure 2** shows how to wire the jack so as to be compatible with a Canon camera.

Provision has been made for two additional terminal blocks (K4 and K5) in case the project is going to be used to drive something other than a Canon camera. In this case, the positions of the S5 switches depend on the application.

Each output has an LED to let you see at a distance if one of the relays is on or not. The buzzer BZ1 offers the possibility of producing an audible signal, for those instances where you might not be able to see the LEDs.

The remote control signal is picked up by IR detector IC3.

Transistor T1 is used to enable the backlight only when it is needed — a handy function that all too often still gets overlooked.

Thanks to regulator IC1, the circuit can be powered from any voltage between 8 and 12 Vdc.

Software

As for every microcontroller circuit, the software is what makes all the functions possible. Here, the software (available free from [1]) has been written in C and compiled using the free 'lite' version of the Hi-Tech C for PIC10/12/16 compiler (version 9.70) [2]. Interaction with the software is achieved via a series of menus, around which we navigate with the help of the four push-buttons S1–S4. Their function depends on the menu selected and is displayed on the LCD using little 'icons'.

If S1 is pressed while power is applied to the circuit, the software goes first into configuration mode before going into normal mode. A series of menus appear that let you configure the remote-control keys (**Figures 3 and 4**) that will be recognized by the timer (see **Table 1**, don't use the same code twice!) and the number of photos to be taken (**Figure 5**). In these menus, pressing S2 decreases the value displayed, while pressing S3 increases it. S1 lets you store the value in the EEPROM and go on to

the next menu. S4 is only used in the third menu, where it offers the possibility of enabling the backlight.

In normal mode, a menu is displayed (**Figure 6**) that shows the status of the buzzer (S3) and pre-focus (S2). Pressing S4 brings up a new menu where S2 and S3 are used to set the time delay between shots from 0 to 3,599 seconds (i.e. 1 hour less 1 second, **Figure 7**). For user convenience, if you keep one of these two switches pressed, the value increases or decreases automatically. This function works in the other menus too.

Table 1:

The codes for some of the keys on an SIRC remote control, as seen by the timer. It only accepts codes between 128 and 137, i.e. the '0' to '9' keys.

HEX	decimal	key
0x80	128	1
0x81	129	2
0x82	130	3
0x83	131	4
0x84	132	5
0x85	133	6
0x86	134	7
0x87	135	8
0x88	136	9
0x89	137	0
0x8C	140	1-
0x8D	141	2-
0x90	144	Program+
0x91	145	Program-
0x92	146	Volume+
0x93	147	Volume-
0x94	148	Mute
0x95	149	Standby
0x96	150	Normal
0xA5	165	TV/Video
0xB4	180	+
0xB5	181	-
0xB6	182	Sleep
0xBA	186	Display
0xBC	188	Select

COMPONENT LIST

Resistors

(5%, 0.25 W unless otherwise indicated)

R1 = 4.7k Ω
 R2 = 100 Ω
 R3 = 10 Ω , 0.5 W
 R4 = 2.7 k Ω
 R5,R6 = 68k Ω
 R7,R8 = 1k Ω
 R9,R10 = 100k Ω
 P1 = 10k Ω trimpot, horizontal

Capacitors

C1 = 470 μ F 25V radial
 C2,C3,C5,C6 = 100nF ceramic
 C4 = 47 μ F 16V radial
 C7,C8 = 22pF ceramic NPO
 C9 = 4.7 μ F 16V radial

Semiconductors

D1,D2 = 1N4004
 D3,D4 = LED, red, low current, 3mm
 IC1 = 7805, TO-220 case
 IC2 = PIC16F886-I/SP, SPDIP28
 IC3 = TSOP1138, 38 kHz IR receiver (e.g. Farnell # 4913036)

T1 = BC337

T2,T3 = BC547

Miscellaneous

BZ1 = piezo buzzer, lead pitch 7.62mm (e.g. Farnell # 1502726)
 RE1,RE2 = relay, miniature SPST-NO, 5 VDC (e.g. Farnell # 9561757)
 K1,K4,K5 = PCB terminal block, lead pitch 5mm
 K2 = 8-pin pinheader, lead pitch 0.1 inch
 K3 = 5-pin pinheader, lead pitch 0.1 inch
 K6 = 2.5mm 3-way jack socket (e.g. Farnell # 1308867)
 LCD1 = LCD, 4x20 (e.g. Elektor # 050176-73)
 S1-S4 = SPNO pushbutton (e.g. Farnell # 1555982)
 S5 = 2-element DIP switch
 X1 = 4MHz quartz crystal
 SPDIP28 socket for IC2
 PCB, Elektor # 081184-1 [1]



If your version of the timer works first time, it's thanks to Daniel in the Elektor lab. If it doesn't work, then it's entirely your own fault.

Pressing S4 starts shooting. The Focus output is active for 400 ms ten seconds before each shot is taken (if pre-focusing has been enabled, of course). Depending on how the buzzer is configured, this event may be accompanied by an audible signal. Firing the Trigger output, also for 400 ms, also activates the buzzer (if enabled). The elapsed time is displayed briefly, and pressing S3 lets you mute the buzzer.

The number of photos taken is updated then displayed on the LCD after each shot (Figure 8). Pressing S4 for at least 2 s allows you to stop the count at any time and go back to the start menu.

If the timer finishes its program without being interrupted, it plays a little tune and then goes into stand-by. You then have to reboot it, or 'wake it up' using the remote control, followed by a long (at least 2 s) press on S4 to start a new series of photos.

Remote control

As indicated above, the timer can be controlled by a Sony remote control or any other remote capable of 'speaking' SIRC [3] — for example, a 'universal' remote. The remote lets you activate the Trigger or Focus outputs manually at any moment (except in stand-by) without affecting the

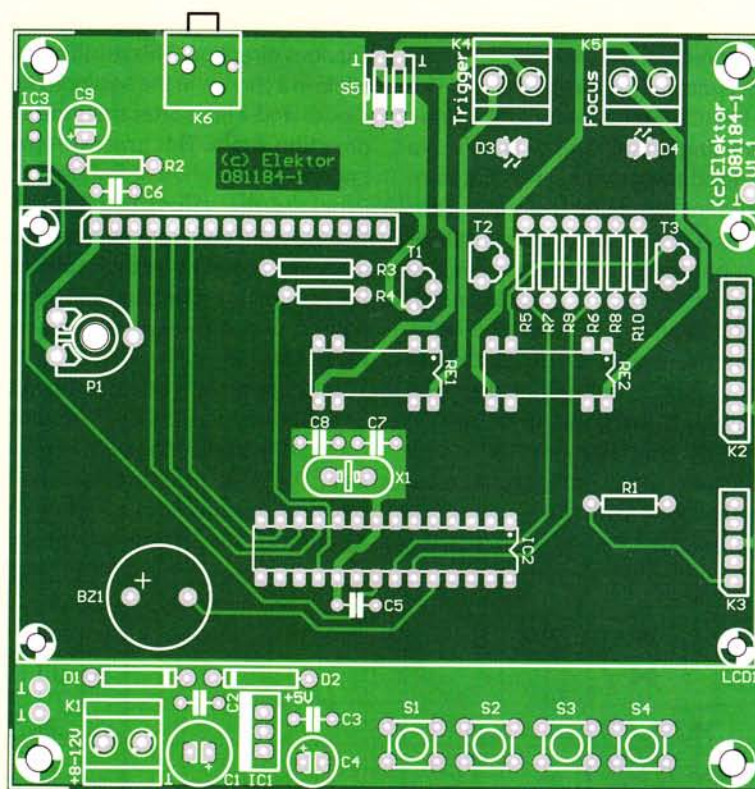

program currently running. It also lets you 'wake up' the circuit, in association with S4. This is possible through the use of an external interrupt, provided by IC3.

Table 1 shows the correspondence between the remote control key number (as seen by the timer) and its function as envisaged by Sony.

(081184)

Internet Links

- [1] www.elektor.com/081184
- [2] www.htsoft.com/downloads/
- [3] picprojects.org.uk/projects/sirc/

Light Tracker

Simple means sometimes provide amazingly good results. For instance, the present circuit is able to track a source of light, such as the sun or a powerful torch, provided, of course, that its output is connected to a small motor. It may be used, for instance, to ensure that solar cells are always directed towards the sun, or to make a robot cart follow a track, or whatever the reader may decide. The circuit is intended to be linked to a small motor with some hysteresis that allows the circuit to rotate 360 degrees. The motor moves clockwise or anti-clockwise until the brightest light is detected.

The circuit is virtually self-explanatory. The IC, Type 74HC240, contains eight logic gates (inverting amplifiers) of which two are connected in parallel three times to ensure sufficient current for the motor. Each motor driver is controlled by one amplifier to which a photodiode is connected. The two diodes are connected in anti-parallel. When light falls on to one diode, this delivers a current the level of which depends on the luminous flux. If the light incidence on the two diodes is the same, the resulting diode currents cancel one another. In case of unequal fluxes, the resultant current is that from the diode with the greatest flux onto it. This current causes an increasing

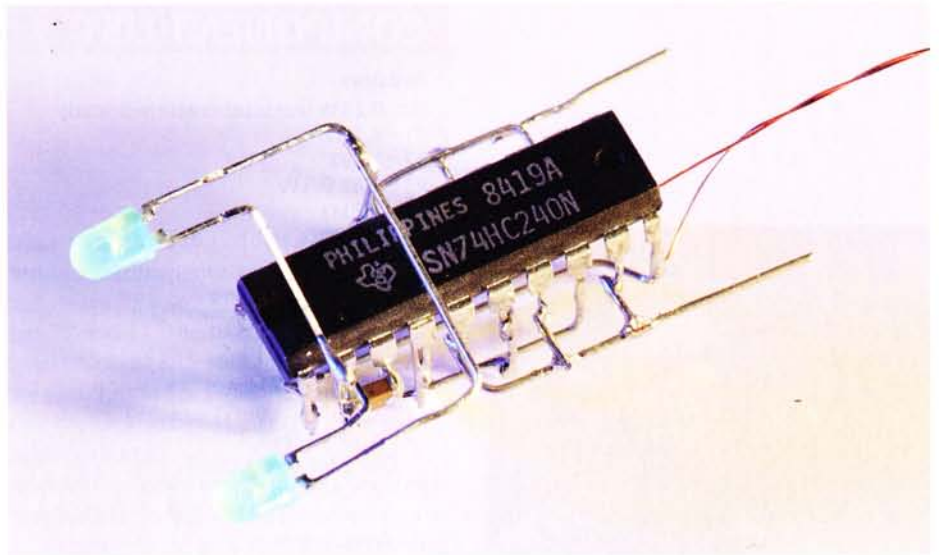

charge on either C1 or C2 and a diminishing one on the other capacitor. This results in a changing voltage across the capacitors and at a certain instant this change will be enough to cause the relevant logic gate to switch its output level. The motor then changes direction. This results after a short while in a change in the luminous flux on the diodes and a little later the motor changes direction again. This process repeats itself endlessly.

Provided the values of C1 and C2 have been chosen correctly, the motor assumes a stable position and should not wobble around the direction of the strongest light. If it does, reduce the value of the two capacitors.

The IC operates from supply voltages of 2–6 V, which means that the motor must be capable of working with the same voltage. The IC is intentionally a buffer type because this provides a higher current at its outputs. Nevertheless, the total current

from the three parallel-connected outputs should not exceed 100 mA to prevent the IC from over-heating.

The photodiodes may be of a variety of types. However, they differ in light sensitivity and two aspects should therefore be borne in mind. A less sensitive diode will function only with sufficiently strong light, so it should be used only in the outdoors, not in enclosed spaces. Also, such a diode provides a smaller current and this will increase the likelihood of motor wobble. This may, of course, as mentioned before, be countered by reducing the values of C1 and C2.

The photograph of the prototype shows that even standard, low-cost LEDs may be used as sensors. Their sensitivity is, however, small and they therefore provide a current of only a few milliamperes. In other words, they are usable only in bright sunlight.

(064009-1)

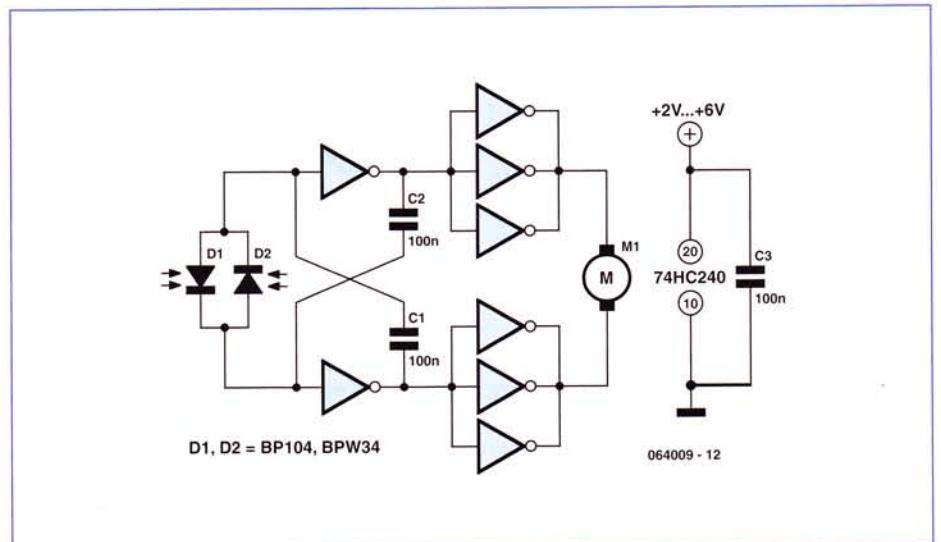
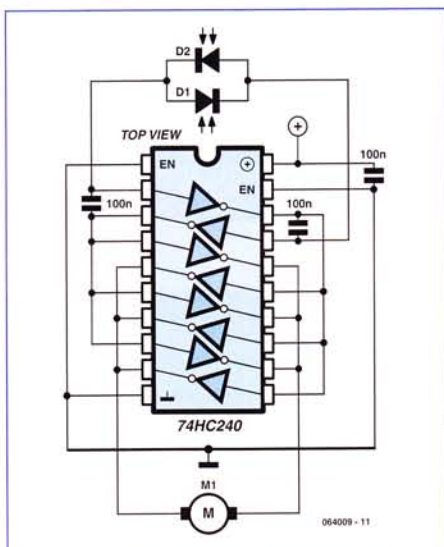

Hexadoku

Puzzle with an electronics touch

It's gratifying to see the monthly response to Hexadoku measured in terms of correct solutions received from readers all over the globe. Thank you all for making this a success and do you reckon you can solve the one below? Enter the right numbers in the puzzle, send the ones in the grey boxes to us and you automatically enter the prize draw for four Elektor Shop vouchers. Have fun!

The instructions for this puzzle are straightforward. Fully geared to electronics fans and programmers, the Hexadoku puzzle employs the hexadecimal range 0 through F. In the diagram composed of 16 x 16 boxes, enter numbers such that **all** hexadecimal numbers 0 through F (that's 0-9 and A-F) occur once only in each row, once

in each column and in each of the 4x4 boxes (marked by the thicker black lines). A number of clues are given in the puzzle and these determine the start situation. Correct entries received enter a draw for a main prize and three lesser prizes. All you need to do is send us the numbers in the grey boxes.

Solve Hexadoku and win!

Correct solutions received from the entire Elektor readership automatically enter a prize draw for one Elektor Shop voucher worth £ 80.00 and three Elektor Shop Vouchers worth £ 40.00 each, which should encourage all Elektor readers to participate.

Participate!

Before December 1, 2010, send your solution (the numbers in the grey boxes) by email, fax or post to
Elektor Hexadoku - 1000, Great West Road - Brentford TW8 9HH
United Kingdom.
Fax (+44) 208 2614447 Email: hexadoku@elektor.com

Prize winners

The solution of the September 2010 Hexadoku is: 3AE58.
The £80.00 voucher has been awarded to: Udo Altmann (Germany).
The £40.00 vouchers have been awarded to: Stefanie Kalkbrenner (Germany),
Suzanne Pecado (France) and W.J. Vis (the Netherlands).
Congratulations everyone!

F				1	2	D		A		0	C				
6				9	7	5	1		3	A	F	2	E		
D		A	2	E		0		8	9	B	5	6			
4				A			6			C		D	3		
		B	E			3	0	C		D		6	5		
0	D				1	4	E		2	8		A	9		
		2		5		9		3	7	F	B	0	E	4	
9	3	8		C	6	A				B	5		7		
5			D	F	8	2									
		1						F	6	0		4			
C	7		8	4		6			3				A	D	
	F	6	A	1	3		7		4		2		B		
	C				5						2				
	B			8		D	C	0						5	
	5	F			2		6	A		1			C		
	A	7			4	F			9			3	8		B

(c) PZZL.com

F	8	3	4	C	2	B	7	1	0	D	5	6	9	E	A
A	0	5	6	D	4	F	9	C	E	7	3	B	8	2	1
E	D	C	1	8	0	5	A	2	6	B	9	F	7	3	4
2	9	B	7	E	6	1	3	F	4	A	8	C	D	0	5
D	3	A	E	5	8	6	0	B	7	4	F	9	1	C	2
9	1	0	C	4	F	7	B	E	D	6	2	3	5	A	8
5	7	6	8	1	9	2	D	0	C	3	A	E	4	F	B
4	B	2	F	3	A	E	C	5	8	9	1	7	0	6	D
1	6	4	D	9	B	8	E	3	2	5	0	A	F	7	C
3	E	8	B	A	C	4	2	D	1	F	7	5	6	9	0
0	C	9	5	F	7	3	1	6	A	8	B	D	2	4	E
7	A	F	2	0	5	D	6	4	9	C	E	8	B	1	3
6	4	7	9	2	D	A	5	8	3	1	C	0	E	B	F
B	F	1	A	6	E	C	4	9	5	0	D	2	3	8	7
8	2	D	0	7	3	9	F	A	B	E	4	1	C	5	6
C	5	E	3	B	1	0	8	7	F	2	6	4	A	D	9

The competition is not open to employees of Elektor International Media, its business partners and/or associated publishing houses.

Chauvin-Arnoux MD7

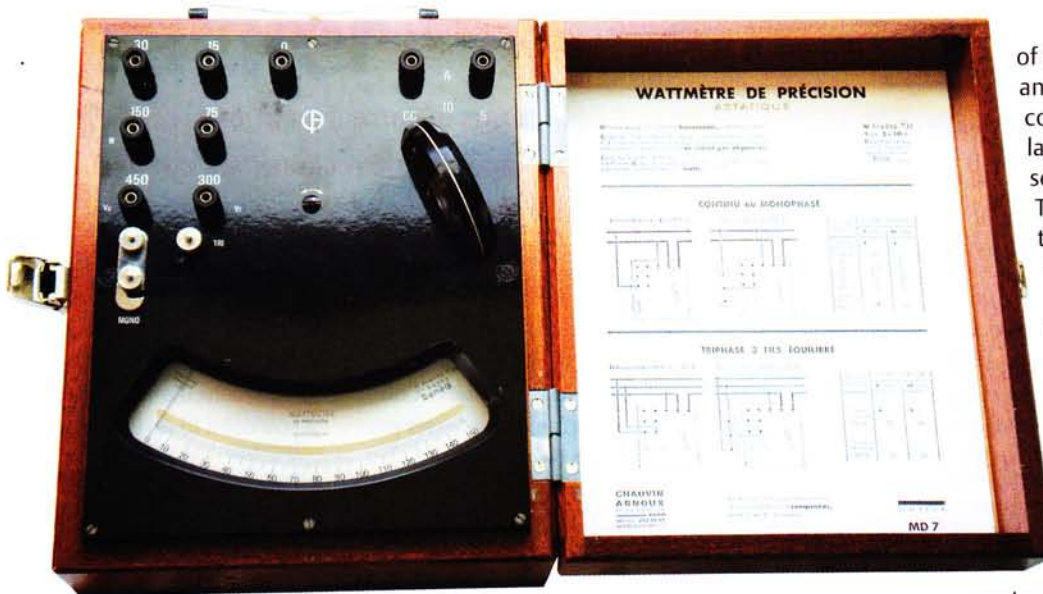

of the two currents: we have created an analogue multiplier. The stationary coil consists of a small number of turns of large-diameter wire and is connected in series with the device under test (DUT). The moving coil has a large number of turns of fine wire and is connected, via a series resistor, in parallel with the DUT. The first is called a 'current winding', the second a 'voltage winding'. This very special voltmeter is the heart of the commonest analogue wattmeters: electrodynamic wattmeters.

Unlike the ferromagnetic voltmeter, the magneto-electric voltmeter can only operate on direct current, since the sense of the deviation depends

By Jean-Marc Dubrunfaut (France)

Since the famous compass that Ampère christened a 'galvanometer', two successive types of voltmeter have held sway. The first of these combined the idea of having the conductor wire make several turns around the needle with Ampère's astatic system (the idea of using two mechanically-coupled magnetic needles with opposing poles, with only one of the needles subject to the influence of the electrical current, in order to get round the problem of the Earth's magnetic field). The second was the moving-coil voltmeter, where it is no longer a magnet that moves within a coil, but a coil that moves within a magnet.

If we combine these two principles by placing one moving coil within another coil, the deviation obtained depends on the product

on the direction of the current. But in the case of a wattmeter, the fact that the polarities to both stationary and moving windings are inverted together means that it works just as well on AC as DC, and without the user even needing to change ranges! Better still, the value obtained in AC is inherently the active power. The deviation is linked to the product of the instantaneous values of voltage and current. This product is smoothed by the inertia of the moving element and by the air damper, hence we obtain the mean value of the instantaneous power, which is what is measured by the supply authority's meter, i.e. $U \times I \times \cos(\phi)$ in the case of a pure sinewave.

And we don't need to do anything further to obtain a value that integrates both AC and DC components, as this is what happens by default. However, one real limitation compared to digital wattmeters is that the frequency of the current to be measured must remain within narrow limits. If it's too low, the mechanical smoothing would be insufficient; if it's too high, the measurement will be distorted by the self-inductance of the coils. The usable operating frequency range of this type of device never exceeds a few hundred hertz (the dial of the MD7 indicates 50 Hz, but our experiments show that it manages ten times that). So this bandwidth excludes high-frequency signals if they are too distorted, because of their harmonics. But at low frequencies, and in particular at 50 Hz, the measurement is accurate for signals of any shape (including squarewaves and clipped sinewaves).

The separate I and U circuits (they are even electrically isolated) offer several advantages. Firstly, they allow a choice between upstream and downstream measurement, which is useful, given the Z_{in} of 5 k Ω . Then, when making measurements on a transformer, there's nothing to stop you measuring the current in the primary and the voltage on the secondary, or vice-versa (not forgetting to take the transformer ratio into account), with the object of making the best use of the input ranges of the device depending on the values to be measured. Lastly, the four terminals makes it possible to significantly extend the range of measurements possible. In this way, it can be adapted to very high currents by using a measuring

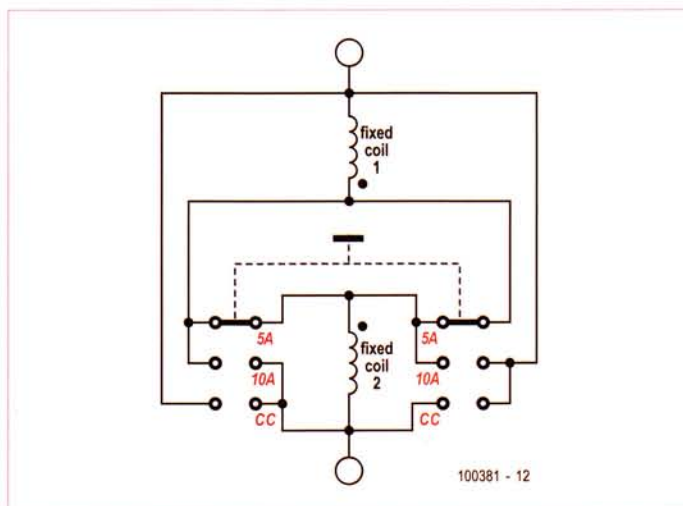

The switch wiring.

Precision Astatic Wattmeter

transformer (the principle of the current clamp), measure just the reactive power, etc.

Astaticism requires the moving element to be doubled up: two moving coils fitted head-to-tail react in an opposing fashion when they are subjected to the same magnetic field. So that they move when under the influence of the current to be measured, each is placed within a dedicated stationary coil, both of which are also wired head-to-tail. So for the system to be astatic, i.e. very little influenced by the Earth's magnetic field or polluters like motors, dynamos, or high-current conductors, we need four coils. So why this costly astaticism when just some good magnetic shielding would have sufficed? Probably because the manufacturer knows, because of their long experience, that such an instrument can lose a great deal of its accuracy because of Foucault currents. In the presence of a massive metallic element, and even more so if it is enclosed in a metal case, a device generating a variable magnetic field will induce Foucault currents into the conductive mass, which will create a magnetic field in opposition to the field that induced them, whence a measurement that is disrupted in a not very predictable manner. "All wood and Bakelite" is not only an aesthetic choice: minimizing the amount of metal as much as possible is also the best technical option, even though that may not be intuitively obvious.

What's more, the designers have taken advantage of this doubling-up of the windings and offered the possibility of wiring the stationary windings in parallel or series, in order to have two current ranges available: 5 A and 10 A. But the selector switch offers a mysterious third position 'CC' to that is not described in the instructions and with no maximum current value.

In fact, in the 'CC' position the current measurement inputs are simply bypassed. So 'CC' doesn't stand for 'DC' (French CC: courant continu), but rather, 'short circuit'! The astatic operation means that the MD7 works as a real synchronous demodulator, i.e. even when placed in a noisy electromagnetic environment, it only extracts that which is at the exact frequency of the current passing through the DUT. It does not react to either static fields or those at different frequencies. But if the DUT itself radiates, the MD7 will include this unwanted field into its measurement. In this event, the 'CC' position makes it possible to measure the spurious field alone. A simple subtraction and the measured value becomes accurate again!

But there's a price to be paid for the accuracy of this fine device. It would be out of the question to subject such a delicate mechanism to any kind of shock. Or to use it without first using a spirit-level to check it is level. What's more, it's obvious that compensating for spurious fields using the famous 'CC' position is only valid if one is careful not to move the instrument at all between the two measurements, nor to change its orientation. And the most important thing of all: be wary of 'invisible' range overloads. You can merrily burn out your collector's piece while the needle is innocently showing very modest values. Not only can the current exceed the set range if the voltage is very low (and vice-versa), but, since what we see is the product of three value (the third being

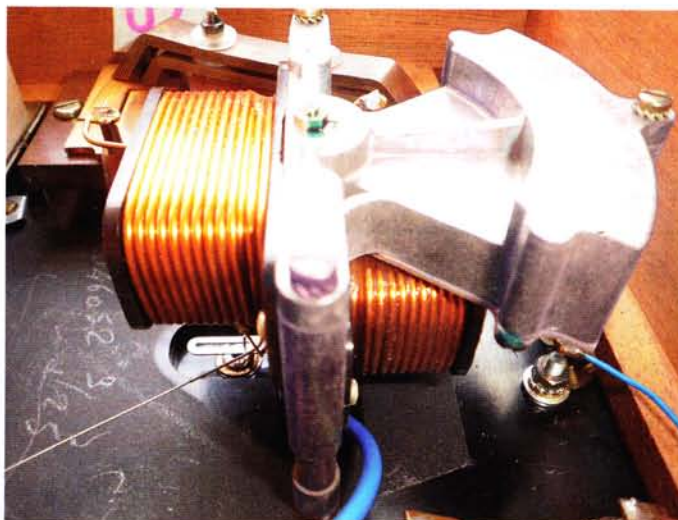

The stationary windings are offset to reduce mutual coupling.

the phase angle $\cos(\phi)$), we can unwittingly burn out both U and I circuits at the same time when the phase angle gets close to 90° . And with a 'single- $\sqrt{3}$ -phase' selector switch connected directly to the voltages being measured, we're a long way from IEC1010 measuring instruments!

(100381)



The range resistors are wound flat so as to have negligible self-inductance and hence an extended frequency response, and are trimmed to the nearest ohm. There are 14 of them (for six ranges), which makes it possible to reduce the power dissipated in each of them (never more than 1.5 watts) and hence the thermal drift — all the more so, since they are particularly well ventilated: accuracy, accuracy, accuracy!

Retronics is a monthly column covering vintage electronics including legendary Elektor designs. Contributions, suggestions and requests are welcomed; please send an email to editor@elektor.com

ELEKTOR SHOWCASE

To book your showcase space contact Huson International Media

Tel. 0044 (0) 1932 564999 Fax 0044 (0) 1932 564998

ASTROBE V3.0

www.astrobe.com

Windows Development System for LPC2000 microcontrollers.

- Develop high-and low-level software without C or assembler
- Generate fast 32-bit native ARM code
- No special programming hardware required
- Personal, Standard and Professional Editions

ATOMIC PROGRAMMING LTD

www.atomicprogramming.com

- AP-114 ISP/JTAG Programming System
- JTAG Programming and Testing
- Boundary Scan Testing
- Universal In-System Programming
- EEPROM and SPI Flash Out-of-Circuit Programming
- Generic GDB Proxy Server
- Jennic JN5148 ZigBee Development Applications
- Training Platform available



AVIT RESEARCH

www.avitresearch.co.uk

USB has never been so simple... with our USB to Microcontroller Interface cable. Appears just like a serial port to both PC and Microcontroller, for really easy USB connection to your projects, or replacement of existing RS232 interfaces.



See our webpage for more details. From £10.00.

BETA LAYOUT

www.pcb-pool.com

Beta layout Ltd Award-winning site in both English and German offers prototype PCBs at a fraction of the cost of the usual manufacturer's prices.



BLACK ROBOTICS

www.blackrobotics.com

Robot platforms and brains for research, hobby and education.

- Make your robot talk!
- TalkBotBrain is open-source
- Free robot speech software
- Robot humanisation technology
- Mandibot Gripper Robot



ByVac

www.byvac.com

- PIC32 With BASIC
- ARM With Forth
- USB to I2C
- Serial Devices
- VT100 LCD Displays



CEDA

www.ceda.in
ceda@vsnl.com

CEDA e-learning
PADS | OrCAD | ALLEGRO
PCB layout @ \$5 Hourly

- PCB Layout @ \$5 Hourly
- Learn PCB Designing with Multimedia DVD in OrCAD, PADS & ALLEGRO
- Self or e-learning with support by email, phone & web-meeting

DESIGNER SYSTEMS

<http://www.designersystems.co.uk>

Professional product development services.

- Marine (Security, Tracking, Monitoring & control)
 - Automotive (AV, Tracking, Gadget, Monitoring & control)
 - Industrial (Safety systems, Monitoring over Ethernet)
 - Telecoms (PSTN handsets, GSM/GPRS)
 - AudioVisual ((HD)DVD accessories & controllers)
- Tel: +44 (0) 845 5192306

EASYSYNC

<http://www.easysync.co.uk>

EasySync Ltd sells a wide range of single and multi-port USB to RS232/RS422 and RS485 converters at competitive prices.



ELNEC

www.elnec.com

Europe's leading device programmers manufacturer:

- reliable HW:
- 3 years warranty for most programmers
- support over 56.000 devices
- free SW updates
- SW release: few times a week
- excellent technical support: Algorithms On Request, On Demand SW
- all products at stock / fast delivery



EMBEDDED ADVENTURES

www.embeddedadventures.com

From news and tutorials to modules, components and kits, we have everything for your next microcontroller based project. Your embedded adventure starts here.



FIRST TECHNOLOGY TRANSFER LTD.

<http://www.ftt.co.uk>

- Training and Consulting for IT, Embedded and Real Time Systems
- Assembler, C, C++ (all levels)
- 8, 16 and 32 bit microcontrollers
- Microchip, ARM, Renesas, TI, Freescale
- CMX, uCOSII, FreeRTOS, Linux operating systems
- Ethernet, CAN, USB, TCP/IP, Zigbee, Bluetooth programming



FLEXIPANEL LTD

www.flexipanel.com

TEAclippers - the smallest PIC programmers in the world, from £20 each:

- Per-copy firmware sales
- Firmware programming & archiving
- In-the-field firmware updates
- Protection from design theft by subcontractors



FUTURE TECHNOLOGY DEVICES

<http://www.ftdichip.com>

FTDI designs and sells USB-UART and USB-FIFO interface i.c.'s.

Complete with PC drivers, these devices simplify the task of designing or upgrading peripherals to USB



HAMEG® Instruments

A Rohde & Schwarz Company

- Oscilloscopes
- Power Supplies
- Spectrum Analyzers
- RF Instruments
- Programmable Measuring Instruments

Great Value in Test & Measurement

www.hameg.com

products and services directory

HEXWAX LTD

www.hexwax.com

- World leaders in Driver-Free USB ICs:
- USB-UART/SPI/I2C bridges
 - TEAleaf-USB authentication dongles
 - expandIO-USB I/O USB expander
 - USB-FileSys flash drive with SPI interface
 - USB-DAQ data logging flash drive

www.elektor.com

STEORN SKDB LITE



Join the SKDB Lite, the place to understand, discuss and experiment with magnetics.

- Learn more about magnetics and electromagnetics
- Participate in developer forums and discussion surrounding magnetics and related topics.

For FREE access to SKDB Lite:
<https://kdb.steorn.com/ref25>

Linear Audio
your tech audio resource

160 pages of tech audio articles
Self, Linkwitz, Cordell, Pass a.o.
www.linearaudio.net

ROBOT ELECTRONICS

<http://www.robot-electronics.co.uk>

Advanced Sensors and Electronics for Robotics

- Ultrasonic Range Finders
- Compass modules
- Infra-Red Thermal sensors
- Motor Controllers
- Vision Systems
- Wireless Telemetry Links
- Embedded Controllers



USB INSTRUMENTS

<http://www.usb-instruments.com>

USB Instruments specialises in PC based instrumentation products and software such as Oscilloscopes, Data Loggers, Logic Analysers which interface to your PC via USB



MQP ELECTRONICS

www.mqp.com

- Low cost USB Bus Analysers
- High, Full or Low speed captures
- Graphical analysis and filtering
- Automatic speed detection
- Bus powered from high speed PC
- Capture buttons and feature connector
- Optional analysis classes



ROBOTIQ

<http://www.robotiq.co.uk>

Build your own Robot!
Fun for the whole family!
Now, available in time for X-mas

- Arduino Starter Kits *NEW!!*
- Lego NXT Mindstorms
- Affordable Embedded Linux Boards
- Vex Robotics (kits and components)
- POB Robots (kits and components)

email: sales@robotiq.co.uk Tel: 020 8669 0769



VIRTINS TECHNOLOGY

www.virtins.com

PC and Pocket PC based virtual instrument such as sound card real time oscilloscope, spectrum analyzer, signal generator, multimeter, sound meter, distortion analyzer, LCR meter.
Free to download and try.

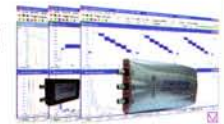

SHOWCASE YOUR COMPANY HERE

Elektor Electronics has a feature to help customers promote their business. Showcase - a permanent feature of the magazine where you will be able to showcase your products and services.

- For just £242 + VAT (£22 per issue for eleven issues) Elektor will publish your company name, website address and a 30-word description
- For £363 + VAT for the year (£33 per issue for eleven issues) we will publish the above plus run a 3cm deep full colour

image - e.g. a product shot, a screen shot from your site, a company logo - your choice

Places are limited and spaces will go on a strictly first come, first served basis. So-please fax back your order today!

I wish to promote my company, please book my space:

- Text insertion only for £242 + VAT
- Text and photo for £363 + VAT

NAME: ORGANISATION:

JOB TITLE:

ADDRESS:

.....

..... TEL:

PLEASE COMPLETE COUPON BELOW AND FAX BACK TO 00-44-(0)1932 564998

COMPANY NAME

WEB ADDRESS

30-WORD DESCRIPTION

.....

.....

.....

.....

.....

Going Strong

A world of electronics
from a single shop!

Visual Studio

C# 2010 Programming and PC interfacing

This book is aimed at anyone who wants to learn about C# programming and interfacing to a PC. It covers programming concepts from the basics to object oriented programming, displaying graphs, threading and databases. The book is complete with many full program examples, self assessment exercises and links to supporting videos. All code examples used are available – free of charge – from the www.elektor.com support website; you can easily create your own results to demonstrate the concepts explained and reinforce your learning in the process. Professional quality software tools are downloadable – also free of charge – from Microsoft. The Microsoft Visual Studio 2010 environment is extensively covered with user controls and their properties, methods and events. Detailed guidance is provided for those wishing to control hardware from a PC with PC interfacing chapters which explain the legacy serial and parallel ports, analogue interfacing using the sound card and use of Microsoft DirectX drivers. Interfacing to the ubiquitous USB port is explained in-depth with a detailed hardware and software design for a USB connected PIC-based hardware target included.

306 pages • ISBN 978-0-905705-95-8 • £29.50 • US \$47.60

Use only free or open source software!

ARM Microcontroller Interfacing

Learn to interface and program hardware devices in a wide range of useful applications, using ARM7 microcontrollers and the C programming language. Examples covered in full detail include a simple LED to a multi-megabyte SD card running the FAT file system. Interface to LEDs, transistors, optocouplers, relays, solenoids, switches, keypads, LCD displays, seven segment displays, DC motors, stepper motors, external analogue signals using the ADC, RS-232, RS-485, TWI, USB, SPI and SD memory cards.

250 pages • ISBN 978-0-905705-91-0
£29.50 • US \$47.60

Get started quickly and proceed rapidly

Python Programming and GUIs

This book is aimed at people who want to interface PCs with hardware projects using graphic user interfaces. The programming language used is Python, an object-oriented scripting language. The book guides you through starting with Linux by way of a free downloadable, live bootable distribution that can be ported around different computers without requiring hard drive installation.

224 pages • ISBN 978-0-905705-87-3
£29.50 • US \$47.60

Books

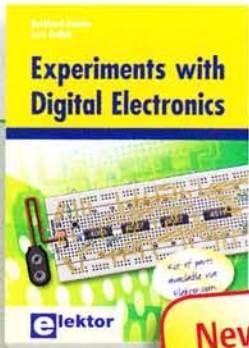

New!

50 practical circuits

Experiments with Digital Electronics

The field of digital electronics is central to modern technology. This book presents fundamental circuits using gates, flip-flops and counters from the CMOS 4000 Series. Each of the 50 experiments has a circuit diagram as well as a detailed illustration of the circuit's construction on solderless breadboard. Building these digital circuits will improve your knowledge and will be fun to boot. Many of the circuits presented here have practical real-life applications. A kit of parts for this book is available via www.elektor.com/digitalexperiments.

176 pages • ISBN 978-0-905705-97-2
£26.50 • US \$42.80

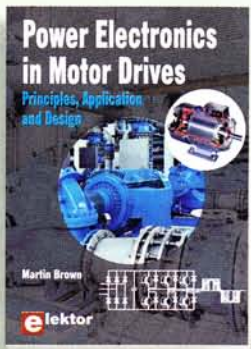

Principles, Application and Design

Power Electronics in Motor Drives

This book is aimed at people who want to understand how AC inverter drives work and how they are used in industry. The book is much more about the practical design and application of drives than about the mathematical principles behind them. The detailed electronics of DC and AC drive are explained, together with the theoretical background and the practical design issues such as cooling and protection.

240 pages • ISBN 978-0-905705-89-7
£29.50 • US \$47.60

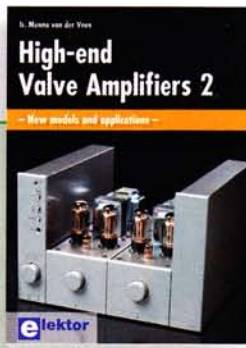

New models and applications

High-End Valve Amplifiers 2

Nobody has any doubt that valve amplifiers produce a remarkably beautiful sound. They have a lively, deep, clear, and expressive sound, and dynamically they do not appear to have any limitations. Menno van der Veen investigates, in a systematic theoretical approach, the reasons for these beautiful properties. He develops new models for power valves and transformers, thus enabling the designer to determine the properties of the amplifier during the design process. You will notice in this book that the author not only writes about amplifier technique, but tells about the way the development of valve amplifiers can have an influence on your daily life; even the usefulness of patents is discussed. Summarizing: new theories and solutions for perfect audio with valve amplifiers. Not only the professional and the DIY-er but everyone who wants to understand valve amplifiers will read this book with much pleasure.

420 pages • ISBN 978-0-905705-90-3
£37.00 • US \$59.70

More information on the Elektor Website:
www.elektor.com

Elektor
 Regus Brentford
 1000 Great West Road
 Brentford
 TW8 9HH
 United Kingdom
 Tel.: +44 20 8261 4509
 Fax: +44 20 8261 4447
 Email: sales@elektor.com



A must-have for audiophiles

DVD Masterclass High-End Valve Amplifiers

In this Masterclass Menno van der Veen will examine the predictability and perceptibility of the specifications of valve amplifiers. The DVD represents 3.5 hours of video material. Bonus elements on the DVD include the complete PowerPoint presentation (74 slides), scanned overhead sheets (22 pcs), AES Publications mentioned during the Masterclass. Not forgetting the bombshell: 25 Elektor publications about valves.

ISBN 978-0-905705-86-6
£24.90 • US \$40.20



Bestseller!

75 Audio designs for home construction

DVD The Audio Collection 3

A unique DVD for the true audio lover, containing more than 75 different audio circuits from the volumes 2002-2008 of Elektor. The articles on the DVD-ROM cover Amplifiers, Digital Audio, Loudspeakers, PC Audio, Test & Measurement and Valves. Highlights include the Clarity 2x300 W Class-T amplifier, High-End Power Amp, Digital VU Meter, Valve Sound Converter, paX Power Amplifier, Active Loudspeaker System, MP3 preamp and much more. Using the included Adobe Reader you are able to browse the articles on your computer, as well as print texts, circuit diagrams and PCB layouts.

ISBN 978-90-5381-263-1
£17.90 • US \$28.90

CD/DVD-ROMS

SHOP BOOKS, CD-ROMs, DVDs, KITS & MODULES

CD/DVD-ROMS

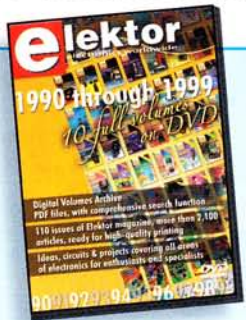

110 issues, more than 2,100 articles

DVD Elektor 1990 through 1999

This DVD-ROM contains the full range of 1990-1999 volumes (all 110 issues) of Elektor Electronics magazine (PDF). The more than 2,100 separate articles have been classified chronologically by their dates of publication (month/year), but are also listed alphabetically by topic. A comprehensive index enables you to search the entire DVD.

ISBN 978-0-905705-76-7
€69.00 • US \$100.00



See the light on Solid State Lighting

DVD LED Toolbox

This DVD-ROM contains carefully-sorted comprehensive technical documentation about and around LEDs. For standard models, and for a selection of LED modules, this Toolbox gathers together data sheets from all the manufacturers, application notes, design guides, white papers and so on. It offers several hundred drivers for powering and controlling LEDs in different configurations, along with ready-to-use modules (power supply units, DMX controllers, dimmers). In addition to optical systems, light detectors, hardware, etc., this DVD also addresses the main shortcoming of power LEDs: heating. This DVD contains more than 100 articles on the subject of LEDs.

ISBN 978-90-5381-245-7
€28.50 • US \$46.00



Bestseller!

The Elektor DSP radio

(July/August 2010)

Many radio amateurs in practice use two receivers, one portable and the other a fixed receiver with a PC control facility. The Elektor DSP radio can operate in either capacity, with a USB interface giving the option of PC control. An additional feature of the USB interface is that it can be used as the source of power for the receiver, the audio output being connected to the PC's powered speakers. To allow portable 6 V battery operation the circuit also provides for an audio amplifier with one or two loudspeakers.

PCB, assembled and tested

Art.# 100126-91 • €149.00 • US \$240.40



InterSceptre

(June 2010)

In our March issue, we introduced Sceptre, a fast prototyping system fitted with a 32-bit microcontroller. Even on its own, this board will let you produce some great results, but if we add an extension board to make it easier to access all its peripherals, the Sceptre platform becomes downright powerful. What's more, if you fit this extension board into a suitable case, you'll be able right from the start to develop a prototype that you can use 'properly' in a installation, with no trailing wires or bits of sticky tape holding everything together. Now that's what you call fast, convenient prototyping!

Kit of parts, contains PCB and components

Art.# 100174-71 • €116.00 • US \$ 187.10



dsPIC Control Board

(May 2010)

This control board has been designed for incorporation into typical industrial electronics applications like controlling motors or adjustment of static up- or down-converters. The objectives were to obtain a board with a large number of pulsewidth modulation (PWM) generators, which enables us to control several motors and static converters at the same time. The cost of the control board needed to be as low as possible too. In addition, it must be possible to construct the board using a soldering iron, without requiring use of a reflow oven.

PCB, populated and tested

Art.# 090073-91 • €140.00 • US \$225.90



Reign with the Sceptre

(March 2010)

This open-source & open-hardware project aims to be more than just a little board with a big microcontroller and a few useful peripherals — it seeks to be a fast prototyping system. To justify this title, in addition to a very useful little board, we also need user-friendly development tools and libraries that allow fast implementation of the board's peripherals. Ambitious? Maybe, but nothing should deter you from becoming Master of Embedded Systems Universe with the help of the Elektor Sceptre.

PCB, populated and tested, test software loaded (excluding Bluetooth module)

Art.# 090559-91 • €89.00 • US \$143.60

Kits & Modules

November 2010 (No. 407) £ US \$

+ + + Product Shortlist November : See www.elektor.com + + +

October 2010 (No. 406)

CL-3 Digital Rotary Combination Lock

100026-41 Atmel ATTINY2313-20PU, programmed..... 8.00.....12.90

Wheelie GT

100479-71 Kit of parts upgrade kit controller board +
2x Hall sensor board 105.00.....169.40

September 2010 (No. 405)

Elektor Project Case

100500-71 Predrilled Lexan sheets with standoffs 14.90.....24.10

Digital Multi-Effects Unit

090835-31 EEPROM 24LC32..... 4.00.....6.50
090835-41 ATmega8-16PU..... 8.30.....13.40
090835-42 ATtiny2313-20PU..... 8.30.....13.40
090835-71 Kit of parts including PCBs, programmed controllers
and EEPROM 165.00.....266.20

Dual Voltage/Current Display

100166-71 Kit of parts incl. PCB, item -41, LCD 62.00.....100.00

Vision System for Small Microcontrollers

090334-1 PCB 19.90 32.10
090334-41 PIC16F690-I/P, programmed 8.00.....12.90

July/August 2010 (No. 403/404)

The Elektor DSP radio

100126-41 ATmega168 PU 12.50.....20.20
100126-91 PCB, assembled and tested..... 149.00.....240.40

Daggerboard Position Detector

080307-41 PIC16F628A-DIL-18, programmed 8.00.....12.90

PICRJ-45 Cable Tester

090643-41 PIC16F72, programmed 8.00.....12.90

3D LED Pyramid

090940-41 ATtiny2313-20SU, programmed 8.00.....12.90

Digital Thumbwheel Switch

090538-41 ATtiny2313 dip20, programmed 8.00.....12.90

Whistler: Electronic Trainer/Coach

100203-41 PIC16F88 DIP18, programmed 8.00.....12.90

Solar Cell Battery Charger/Monitor

090544-41 PIC16F877A, programmed..... 16.50.....26.70

Universal Timer with Zero Standby Current

090534-41 ATTiny2313, programmed 8.00.....12.90

Tiny Timer

091044-41 ATtiny2313, programmed 8.00.....12.90

Universal PWM Driver

090856-41 PIC16F628-1/P, programmed..... 8.00.....12.90

Binary Clock

090187-41 PIC16F877-20/P DIP40, programmed 18.50.....29.90

USB Tilt Sensor

070829-41 ATmega8-16AU (TQFP), programmed 8.00.....12.90
090645-91 MMA7620 breakout board 8.50.....13.80

Bench PSU for PC

090863-41 PIC16F616-I/P, programmed 8.00.....12.90

Sailor's Battery Meter

090117-41 PIC16F690 DIP, programmed 8.00.....12.90

Tiny Pulser

090444-41 ATTINY13-20P4, programmed 8.00.....12.90

MicroMinimal Thermometer

090634-41 ATTINY13(A)dip8, programmed..... 8.00.....12.90

Waterproof Bathroom Switch

090537-41 ATtiny13A, programmed 8.00.....12.90

Lights Control for Model Cars

090834-41 Programmed controller ATTiny45 DIP-8 8.00.....12.90

Modeller's Clock

090023-41 PIC18LF1320 I/P DIL18, programmed 8.00.....12.90

Bestsellers

Books	1	ARM Microcontroller Interfacing ISBN 978-0-905705-91-0.... £29.50US \$47.60
	2	High-End Valve Amplifiers 2 ISBN 978-0-905705-90-3.... £37.00US \$59.70
	3	Power Electronics in Motor Drives ISBN 978-0-905705-89-7.... £29.50US \$47.60
	4	Elektor Personal Organizer 2011 ISBN 978-90-5381-259-4.... £24.90US \$40.20
	5	50 PIC Microcontroller projects ISBN 978-0-905705-88-0.... £36.00US \$58.10
CD/DVD-ROMS	1	DVD The Audio Collection 3 ISBN 978-90-5381-263-1 £17.90US \$28.90
	2	Masterclass DVD High-End Valve Amplifiers ISBN 978-0-905705-86-6.... £24.90 US \$40.20
	3	DVD Elektor 1990 through 1999 ISBN 978-0-905705-76-7 £69.00US \$100.00
	4	DVD LED Toolbox ISBN 978-90-5381-245-7 £28.50US \$46.00
	5	DVD Elektor 2009 ISBN 978-90-5381-251-8 £17.50US \$28.30
Kits & Modules	1	Elektor DSP radio Art. # 100126-91 £149.00 US \$240.40
	2	Reign with the Sceptre Art. # 090559-91 £89.00US \$143.60
	3	OBD2 Mini Simulator Art. # 080804-71 £84.00 US \$135.50
	4	InterSceptre Art. # 100174-71 £116.00US \$187.10
	5	Wheelie GT Art. # 100479-71 £105.00 US \$169.40

Order quickly and securely through
www.elektor.com/shop
or use the Order Form near the end
of the magazine!



Elektor
Regus Brentford
1000 Great West Road
Brentford TW8 9HH • United Kingdom
Tel. +44 20 8261 4509
Fax +44 20 8261 4447
Email: sales@elektor.com

COMING ATTRACTIONS

NEXT MONTH IN ELEKTOR



Stroboscopic PC Fan

Many PC users constantly attempt to adorn their computers with visual gadgets whose main purpose is to draw attention. PC cases with a transparent side panel in particular offer super opportunities for special effects. Our circuit based on an ATtiny25 micro controls an LED in such a way as to make the PC ventilator fan blades appear to stand still, turn slowly in either direction, or turn at intervals. A fascinating effect!

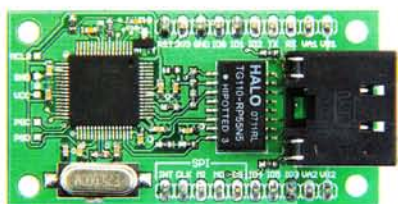

Ethernet Module

Adding an Ethernet connection to your circuit allows you to easily capture data from sensors, actuators and other devices, through the Internet. Unfortunately, many electronics enthusiasts find it hard to master or at least get to grips with the relevant hardware and software. Now, a handy solution is found in a small module comprising a PIC micro with an on-chip Ethernet transceiver, an isolating transformer and a network connector. The project is completed with a free software library and lots of examples to get you going.



Elektor Embedded Special

In the December 2010 edition you can look forward to finding a special insert totally dedicated to embedded projects. Space allowing we'll be covering: an infra-red thermometer, a USB-to-RS485 converter with galvanic isolation, an intelligent modular LED display, a breadboard interface for an XPort module, a carrier board for the Arduino Nano, several projects for our own MiniMod18 and lots more!

Article titles and magazine contents subject to change; please check the Magazine tab on www.elektor.com

Elektor UK/European edition: on sale November 18, 2010. Elektor USA edition: published November 11, 2010.

www.elektor.com www.elektor.com www.elektor.com www.elektor.com www.elektor.com www.elektor.com

Elektor on the web

All magazine articles back to volume 2000 are available online in pdf format. The article summary and parts list (if applicable) can be instantly viewed to help you positively identify an article. Article related items are also shown, including software downloads, circuit boards, programmed ICs and corrections and updates if applicable. Complete magazine issues may also be downloaded.

In the Elektor Shop you'll find all other products sold by the publishers, like CD-ROMs, DVDs, kits, modules, equipment, tools and books. A powerful search function allows you to search for items and references across the entire website.

Also on the Elektor website:

- Electronics news and Elektor announcements
- Readers Forum
- PCB, software and e-magazine downloads
- Time limited offers
- FAQ, Author Guidelines and Contact



ORDERING INSTRUCTIONS, P&P CHARGES

All orders, except for subscriptions (for which see below), must be sent BY POST or FAX to our Brentford address using the Order Form overleaf. Online ordering: www.elektor.com/shop

Readers in the USA and Canada should send orders, except for subscriptions (for which see below), to the USA address given on the order form. Please apply to Elektor US for applicable P&P charges. Please allow 4-6 weeks for delivery.

Orders placed on our Brentford office must include P&P charges (Priority or Standard) as follows: Europe: £6.00 (Standard) or £7.00 (Priority) Outside Europe: £9.00 (Standard) or £11.00 (Priority)

HOW TO PAY

All orders must be accompanied by the full payment, including postage and packing charges as stated above or advised by Customer Services staff.

Bank transfer into account no. 40270211 held by Elektor International Media BV with The Royal Bank of Scotland, London.

IBAN: GB96 ABNA 4050 3040 2702 11. BIC: ABNAGB2L. Currency: sterling (UKP).

Please ensure your full name and address gets communicated to us.

Cheque sent by post, made payable to Elektor Electronics. We can only accept sterling cheques and bank drafts from UK-resident customers or subscribers. We regret that no cheques can be accepted from customers or subscribers in any other country.

GCredit card VISA and MasterCard can be processed by mail, email, web, fax and telephone. Online ordering through our website is SSL-protected for your security.

COMPONENTS

Components for projects appearing in Elektor are usually available from certain advertisers in this magazine. If difficulties in the supply of components are envisaged, a source will normally be advised in the article. Note, however, that the source(s) given is (are) not exclusive.

TERMS OF BUSINESS

Delivery Although every effort will be made to dispatch your order within 2-3 weeks from receipt of your instructions, we can not guarantee this time scale for all orders. **Returns** Faulty goods or goods sent in error may be returned for replacement or refund, but not before obtaining our consent. All goods returned should be packed securely in a padded bag or box, enclosing a covering letter stating the dispatch note number. If the goods are returned because of a mistake on our part, we will refund the return postage. **Damaged goods** Claims for damaged goods must be received at our Brentford office within 10-days (UK); 14-days (Europe) or 21-days (all other countries).

Cancelled orders All cancelled orders will be subject to a 10% handling charge with a minimum charge of £5.00. **Patents** Patent protection may exist in respect of circuits, devices, components, and so on, described in our books and magazines. Elektor does not accept responsibility or liability for failing to identify such patent or other protection. **Copyright** All drawings, photographs, articles, printed circuit boards, programmed integrated circuits, diskettes and software carriers published in our books and magazines (other than in third-party advertisements) are copyright and may not be reproduced or transmitted in any form or by any means, including photocopying and recording, in whole or in part, without the prior permission of Elektor in writing. Such written permission must also be obtained before any part of these publications is stored in a retrieval system of any nature. Notwithstanding the above, printed-circuit boards may be produced for private and personal use without prior permission. **Limitation of liability** Elektor shall not be liable in contract, tort, or otherwise, for any loss or damage suffered by the purchaser whatsoever or howsoever arising out of, or in connexion with, the supply of goods or services by Elektor other than to supply goods as described or, at the option of Elektor, to refund the purchaser any money paid in respect of the goods. **Law** Any question relating to the supply of goods and services by Elektor shall be determined in all respects by the laws of England.

January 2010

SUBSCRIPTION RATES FOR ANNUAL

SUBSCRIPTION

	Standard	Plus
United Kingdom & Ireland	£49.00	£61.50
Surface Mail		
Rest of the World	£63.00	£75.50
Airmail		
Rest of the World	£79.00	£91.50
USA	£64.95	See www.elektor.com/usa for special offers
Canada	£75.95	

HOW TO PAY

Bank transfer into account no. 40270211 held by Elektor International Media BV with The Royal Bank of Scotland, London. IBAN: GB96 ABNA 4050 3040 2702 11. BIC: ABNAGB2L. Currency: sterling (UKP). Please ensure your full name and address gets communicated to us.

Cheque sent by post, made payable to Elektor Electronics. We can only accept sterling cheques and bank drafts from UK-resident customers or subscribers. We regret that no cheques can be accepted from customers or subscribers in any other country.

Credit card VISA and MasterCard can be processed by mail, email, web, fax and telephone. Online ordering through our website is SSL-protected for your security.

SUBSCRIPTION CONDITIONS

The standard subscription order period is twelve months. If a permanent change of address during the subscription period means that copies have to be despatched by a more expensive service, no extra charge will be made. Conversely, no refund will be made, nor expiry date extended, if a change of address allows the use of a cheaper service.

Student applications, which qualify for a 20% (twenty per cent) reduction in current rates, must be supported by evidence of studentship signed by the head of the college, school or university faculty.

A standard Student Subscription costs £39.20, a Student Subscription-Plus costs £51.70 (UK only).

Please note that new subscriptions take about four weeks from receipt of order to become effective. Cancelled subscriptions will be subject to a charge of 25% (twenty-five per cent) of the full subscription price or £7.50, whichever is the higher, plus the cost of any issues already dispatched. Subscriptions cannot be cancelled after they have run for six months or more.

January 2010

Come see us at



electronica 2010

components | systems | applications

Munich, 09-12 November

Visit **elektronica** 2010, the world's leading trade fair for components, systems and applications.

Meet the makers of Elektor:

Hall A5 / Booth #531

New Munich Trade Fair Centre

Opening hours:

Tuesday-Thursday 09-11 November 9 a.m. – 6 p.m.

Friday 12 November 9 a.m. – 5 p.m.



**Eingang West
Entrance West**

electronica 2010
components | systems | applications

Further information at www.electronica.de/en

INDEX OF ADVERTISERS

Astrobe, Showcase www.astrobe.com	78	Linear Audio, Showcase www.linearaudio.net	79
Atomic Programming Ltd, Showcase www.atomicprogramming.com	78	Microchip www.microchip.com/xlp	13
Avit Research, Showcase www.avitresearch.co.uk	78	MikroElektronika www.mikroe.com	3
Beijing Draco Electronics Ltd www.ezpcb.com	57	MQP Electronics, Showcase www.mqp.com	79
Beta Layout, Showcase www.pcb-pool.com	59, 78	Nurve Networks www.xgamestation.com	59
Black Robotics, Showcase www.blackrobotics.com	78	NXP Contest www.circuitcellar.com/nxpmbeddesignchallenge	2
ByVac, Showcase www.byvac.com	78	Pico www.picotech.com/scope2023	39
CEDA, Showcase www.ceda.in	78	Quasar Electronics www.quasarelectronics.com	15
Designer Systems, Showcase www.designersystems.co.uk	78	Robot Electronics, Showcase www.robot-electronics.co.uk	79
Easysync, Showcase www.easysync.co.uk	78	Robotiq, Showcase www.robotiq.co.uk	79
Elnec, Showcase www.elnec.com	78	Showcase	78, 79
Embedded Adventures, Showcase www.embeddedadventures.com	78	Stearn SKDB Lite, Showcase www.kdb.stearn.com/ref25	79
Embedded Live www.embedded-live.com	53	Temwell Corporation www.temwell.com.tw	11
Eurocircuits www.eurocircuits.com	23	USB Instruments, Showcase www.usb-instruments.com	79
First Technology Transfer Ltd, Showcase www.ftt.co.uk	78	Virtins Technology, Showcase www.virtins.com	79
FlexiPanel Ltd, Showcase www.flexipanel.com	78		
Future Technology Devices, Showcase www.ftdichip.com	9, 78		
Hameg, Showcase www.hameg.com	78		
HexWax Ltd, Showcase www.hexwax.com	79		
Labcenter www.labcenter.com	88		

Advertising space for the issue 23 December 2010 may be reserved not later than 23 November 2010
with Huson International Media - Cambridge House - Gogmore Lane - Chertsey, Surrey KT16 9AP - England - Telephone 01932 564 999 - Fax 01932 564 998 - e-mail: ros.elgar@husonmedia.com to whom all correspondence, copy instructions and artwork should be addressed.

PRE-PRODUCTION CHECK

Board Edge Defined - CHECK

All Components Placed - CHECK

All Connections Routed - CHECK

Power Planes Generated - CHECK

No Design Rule Violations - CHECK

PROTEUS 7

Design with Confidence:

The latest version of the Proteus PCB Design Software provides a multi-stage Pre-Production Check which will detect and prevent a variety of common mistakes prior to your boards being sent for manufacture.

PROTEUS DESIGN SUITE Features:

- Hardware Accelerated Performance.
- Unique Thru-View™ Board Transparency.
- Over 35k Schematic & PCB library parts.
- Integrated Shape Based Auto-router.
- Flexible Design Rule Management.
- Polygonal and Split Power Plane Support.
- Board Autoplacement & Gateswap Optimiser.
- Direct CAD/CAM, ODB++, IDF & PDF Output.
- Integrated 3D Viewer with 3DS and DXF export.
- Mixed Mode SPICE Simulation Engine.
- Co-Simulation of PIC, AVR, 8051 and ARM7.
- Direct Technical Support at no additional cost.

All levels of the Proteus Design Suite include a world class, fully integrated shape-based autorouter at no additional cost - prices start from just £150 exc. VAT & delivery

labcenter  www.labcenter.com
Electronics

Labcenter Electronics Ltd. 53-55 Main Street, Grassington, North Yorks. BD23 5AA.
Registered in England 4692454 Tel: +44 (0)1756 753440, Email: info@labcenter.com

Visit our website or
phone 01756 753440
for more details